

spex



FOR HOGGI BINGO OT

SCRIPTING AND ORDERING GUIDE

Client Details

Client/User name:	
Date:	
DOB:	

Notes

Notes





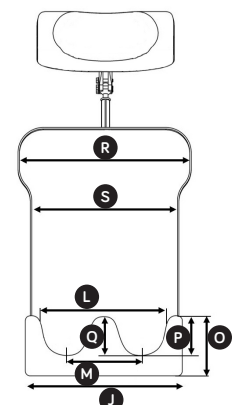
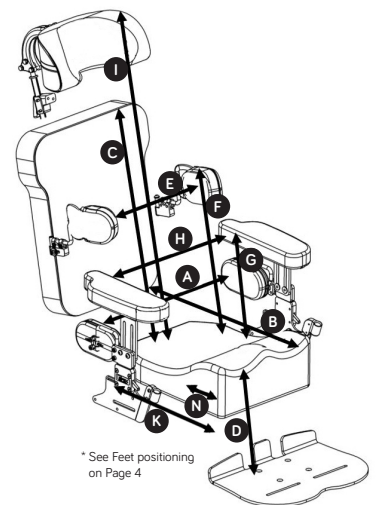

Further Information

COMPULSORY SELECTION ITEMS

BINGO Stroller Size		Size 1		Size 2	
BINGO Stroller Order Code		2885-0031-032		2885-0032-032	
Seating specs	A Hip width	17-28cm (6.5-11")		22-33cm (8.5-13")	
	B Seat depth	18-30cm (7-12")		23-38cm (9-15")	
	C Back height	36-44cm (14-17")		40-48cm (16-19")	
	D Lower leg length*	25-40cm (10-16")		25-45cm (10-18")	
	E Trunk lateral width	12-28cm (5-11")		15-30cm (6-12")	
	F Trunk lateral height	15-34cm (6-13.5")		17-40cm (6.5-16")	
	G Arm support height	15-22cm (6-8.5")		15-22cm (6-8.5")	
	H Internal arm support width	20-32cm (8-13")		28-38cm (11-15")	
	I Head support height	45-65cm (18-25.5")		50-70cm (20-28")	
	J Cushion total width	33cm (13") Size 1.1	33cm (13") Size 1.2	38cm (15") Size 2.1	38cm (15") Size 2.2
	K Cushion total depth	33cm		38cm	
	L Internal cushion width	23cm (9") Size 1.1	28cm (11") Size 1.2	28cm (11") Size 2.1	33cm (13") Size 2.2
	M Centre of thigh contours	15cm (6") Size 1.1	17cm (6.5") Size 1.2	18cm (7") Size 2.1	20cm (8") Size 2.2
	N Thigh contour depth	10cm (4") Size 1.1	12cm (5") Size 1.2	12cm (5") Size 2.1	15cm (6") Size 2.2
	O Cushion side height	14cm (5.5")		14cm (5.5")	
	P Thigh contour height	9cm (3.5")		9cm (3.5")	
Q Abductor contour height	5cm (2")		5cm (2")		
R Back cushion width	33cm (13")		38cm (15")		
S Trunk cushion width	26cm (10")		30cm (12")		
Stroller specs	Frame seat depth capacity	18-30cm (7-12")		20-38cm (8-15")	
	Frame back height capacity	36-46cm (14-18")		41-55cm (16-22")	
	Backrest recline angle	90-160°			
	Height of push bar	75-110cm (29.5-43")			
	Overall frame width	63cm (25")		68cm (27")	
	Max load of seat unit	50kg (110lb) (body weight including other load)			
	Base frame capacity	60kg (132lb)			



Colour Selection

Jet <input type="radio"/>	Royal <input type="radio"/>	Chilli <input type="radio"/>	Mango <input type="radio"/>	Bumblebee <input type="radio"/>
				
-099	-077	-022	-030	-044
Ocean <input type="radio"/>	Leaf <input type="radio"/>	Calypso <input type="radio"/>	Granite <input type="radio"/>	Ink <input type="radio"/>
				
-060	-054	-028	-090	-209

Wipe down

Cushion Selection



Size 1.1 <input type="radio"/>	Size 1.2 <input type="radio"/>	Size 2.1 <input type="radio"/>	Size 2.2 <input type="radio"/>	
33cm (13") total width 23cm (9") internal width Fits BINGO Size 1	33cm (13") total width 28cm (11") internal width Fits BINGO Size 1	38cm (15") total width 28cm (11") internal width Fits BINGO Size 2	38cm (15") total width 33cm (13") internal width Fits BINGO Size 2	
Recommended for 18-23cm seat depth	Recommended for 23-30cm seat depth	Recommended for 23-33cm seat depth	Recommended for 28-38cm seat depth	
2885-0610	2885-0611	2885-0612	2885-0613	

Back Supports

Spex Contouring Back System

For Size 1 BINGO 2885-2012 <input type="radio"/>	
For Size 2 BINGO 2885-2014 <input type="radio"/>	

Head Supports

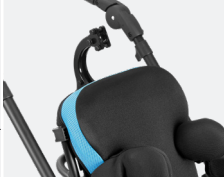
Standard Lateral <input type="radio"/> with Stylo hardware & BINGO attachment	Extended Lateral <input type="radio"/> with Stylo hardware & BINGO attachment	Mount and stem hardware <input type="radio"/> = Stylo hardware and BINGO attachment
For moderate head positioning needs.	For complex head positioning needs.	For use with other Spex head pads
		
2885-4241	2885-4341	2885-4510-000

Arm Supports

Arm Supports

With height-adjustable, quick-release hardware and neoprene cover.

To fit Size 1 2885-5621-291	<input type="radio"/>
To fit Size 2 2885-5622-291	<input type="radio"/>



Pelvic Supports

Pelvic Supports

Mounts onto arm support bracket (pair) behind cushion troughing (arm supports must be selected).

To fit Size 1 2885-1111-000	<input type="radio"/>
To fit Size 2 2885-1112-000	<input type="radio"/>



Lateral Supports

Narrow lateral supports

Soft padding/neoprene cover (pair) with Axial Technology.

8.5cm high x 11.5cm deep

2885-3410-291

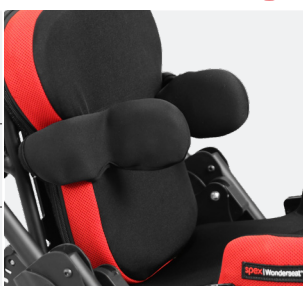

Broad lateral supports

Soft padding/neoprene cover (pair) with Axial Technology.

10.5cm high x 13cm deep

2885-3431-291

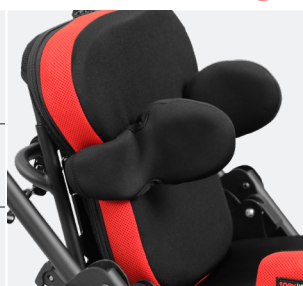

ACCESSORY SELECTION ITEMS

Shoulder Harness

X-Small Centrepoint Small Centrepoint

Pad height 26cm, total pad width 22cm	Pad height 36cm, total pad width 32cm
1409-6660-017	1409-6661-017



Hip Belt

2 Point Hip Belt 4 Point Hip Belt

2-point, padded dual centre pull, side release buckle

X-Small (Pad width 30cm) 1405-6220-027	<input type="radio"/>
Small (Pad width 36cm) 1405-6221-027	<input type="radio"/>



4-point, padded dual centre pull, side release buckle

X-Small (Pad width 30cm) 2006-6400-027	<input type="radio"/>
Small (Pad width 36cm) 1406-6421-027	<input type="radio"/>





Manufactured by Spex Ltd

32 Detroit Drive
Rolleston 7675
New Zealand

+64 3 307 9790

solutions@spexseating.com

www.spexseating.com



DISTRIBUTED BY:

US	REP	EC	REP
Medcept 200 Homer Ave, Ashland MA 01721, United States Tel: +1-508-231-8842		BEO MedConsulting Berlin GmbH Helmholtzstr. 2 D-10587 Berlin, Germany Tel: +49-30-318045-30	



Script: BINGOSpexInternational_20222209

BINGO ARTG #:
160785