SHUTTLE
DISCOVERY
User Manual

User Name:

Serial Number:

medifab

Welcome

Thank you for purchasing the Shuttle Discovery. The Shuttle Discovery is a versatile, growth-adjustable seat system complete with unique body supports that can be used in a variety of base options. The Shuttle Discovery has been designed to complement the development of the user. This manual shows how you can safely make use of all the functions your Shuttle Discovery has to offer. The correct use and maintenance of your Shuttle Discovery will ensure that you will enjoy a long trouble free use.

The safety advice and directions in this manual cannot cover all eventualities and unforeseen situations that may occur. It must be understood that common sense, general caution and care are factors that cannot be built into this product. These are factors which the person caring for the user must assume responsibility for.



Read Before Use

All prescribers and caregivers who use this product should read and understand this manual prior to use. The safety of the user is the caregiver's responsibility. It is important to the user and caregiver's safety that the product functions and safety aspects are understood, and that the product is used correctly.

Medifab recommends that set-up, fittings, and adjustments be performed after carefully reading this manual.

It is important to consider the user's positioning, physical limitations, and needs when configuring this product. Consult the user's health care provider with any questions regarding the set up and use of this product.

Contact Medifab for assistance with set up and assembly, if required. Medifab will also be able to provide advice regarding the safe use of this product, if required.

Contents

General Information and Before Starting	06
Product Induction	07
Warnings and Safety Notes	08
Assembling the Verve Stroller	13
Assembling Discovery Seat	14
Backrest/Hip Supports	15
Laterals/Footplate Padding/Seat Padding	16
Backrest Padding/Headrest	17
Discovery Seat Set-Up	18
Seat Depth	18
Seat Width	19
Backrest Angle and Locking	20
Backrest Height/Footplate Height, Angle	21
Thoracic Laterals	22
Tilt-in-Space	23
Using the Verve Stroller	24
Installing/Removing Discovery Seat	26
Storage	27
Transporting Shuttle Discovery in vehicle	28
Warnings	28
Securing Shuttle Discovery for Transport	29
Securement latch brackets	30
Securing Discovery Seat for Transport	31
Accessories	32
5 point harness/2 & 4 point pelvic straps	32
5 point harness	33
5 point harness/Tee pad/Centrepoint	34
Jacket/Sternum Harness	35
4 point pelvic strap	36
Abduction bracket and support	37
Thigh and Head Supports	38
IV Pole & Oxygen Bottle Holder	40
Seat Wedges	41
Modular Cushion	42
Trays & Tray Accessories	44
Foot straps and Footplate Accessories	48
Sunhood & Snuggle Warmer	49
Moon Rock Base	50
Hi-Lo Base & A-Frame Launcher Base	52
Lunar Base	55
Rain Cover & Sibling seat	57
Cleaning and Care	58
Reissue	59
Maintenance: Daily checks	59
Maintenance: Six-monthly Checks	61
Product Log Form	65
Servicing and Technical Data	66

Symbol Glossary



Warning or Caution - Consult Instructions for Use



Manufacturer



Date of Manufacture



Batch Code



Catalogue Number



Serial Number



Maximum weight limit



Consult Instructions for Use

General Information

The Shuttle Discovery system is an early intervention seating system. The Discovery Seat is designed for special needs persons up to 25 kg (55 lb). The Discovery Seat can be used with outdoor and indoor bases. Shuttle Discovery provides the freedom to explore the outdoors. The Discovery Seat with Verve Stroller is referred to in this manual as the Shuttle Discovery. The indoor bases - Moon Rock, Lunar, and Hi-Lo - allow the Discovery Seat to be used at school or at home.

Potential client groups include:

- Cerebral Palsy
- Low Tone
- Spastic Diplegia
- Autism
- Children with Cognitive Difficulties

Shuttle Discovery components are prescription and over-the-counter medical devices.

Intended Use

The Shuttle Discovery is intended for use as a manual wheelchair. It is indicated for use to provide mobility to persons with disabilities who are partially or permanently non-ambulatory and limited to a sitting position.

Declaration of Conformity

The Shuttle Discovery has the CE-mark. This certifies that it meets relevant European safety requirements.

Medifab declares that the Shuttle Discovery conforms to international ISO 7176 Wheelchairs standards.

Information on specific wheelchair testing is available on request.

The Shuttle Discovery has been classified as a class 1 product according to the classification criteria outlined in annex IX of 93/42/EEC Guidelines.

US REP: Medicept
 200 Homer Ave
 Ashland, MA 01721
 United States

EU REP : BEO MedConsulting Berlin GmbH
 Helmholtzstr. 2
 D-10587 Berlin

Warranty

Medifab warrants that equipment sold by Medifab will be free of all defects in material and workmanship for a period of 2 years from the date of purchase. We will not be held responsible for any damage or injury due to misuse or modification of our products. If any part of the equipment is found to be defective within the terms and period of this warranty Medifab will, at its own discretion, repair or replace it.

Before Starting

- **Always read** the instructions before use. Failure to follow instructions may impair use, impede function and more importantly, may affect the user's or caregiver's safety.

Discovery Seat: 2006-0010-000

Verve Stroller: 2006-0040-000

Moon Rock Base: 2006-0014-000

Hi-Lo Base: Gas: 2006-0016-000 / Powered: 2006-0018-000

Lunar Base: 2006-0013-000

- **Each product** has a serial number which can be found on the product. Please quote this number in any correspondence. See Page 62 for location of serial numbers on the products.
- **Materials and foam** within the product meet all the required current regulations. In rare cases the fabrics used in this product may cause a skin irritation for people with sensitive skin.
- **Do not** add any other accessories other than those supplied by Medifab to this product.
- **The Discovery Seat** is suitable for a small person with a maximum weight of 25 kg (55 lb).
- **Service or repair** must only be carried out by a Medifab authorised service person.
- **Any service** or repair carried out by any other person will invalidate the guarantee and Medifab cannot accept any liability for injury or damage thus caused.
- **The tools** required to adjust the Shuttle Discovery are a 10mm ring spanner/ socket and 4mm hex allen key.
- **Ensure** Shuttle Discovery is fully assembled before use.
- **It is essential** Shuttle Discovery is cleaned regularly so as not to impede function and to remain hygienic. See Cleaning and Care section of this manual, Page 57.
- **Read the instruction manual** and be fully aware of all available adjustments.
- **The prescriber or caregiver** has the responsibility to ensure the product is correctly set up to meet the user's needs.
- **Shuttle Discovery** is not provided as a sterile product

- **Prescribers and caregiver(s)** should be made aware of the following key sections of this manual;
 - **Before Starting:** Page 07
 - **WARNINGS** Pages 08-12
 - **Backrest angle and locking:** Page 20
 - **Footplate Angle:** Page 21
 - **Tilt-in-space:** Page 23
 - **Using the Verve Stroller:** Pages 24-25
 - **Installing & Removing the Discovery Seat:** Page 26
 - **Storing your Shuttle Discovery:** Page 27
 - **Transporting Shuttle Discovery in a Vehicle:** Pages 28-31
 - **Adjusting the Pelvic Straps / Harnesses** Pages 32-36
 - **Fitting the Abduction support:** Page 37
 - **Using the Tray:** Pages 44-47
 - **Adjusting foot straps:** Page 48
 - **Using the Moon Rock Base:** Pages 50-51
 - **Using the Hi-Lo Base:** Pages 52-53
 - **Using the Lunar Base:** Pages 54-55
 - **Cleaning and Care Information:** Page 57
 - **Maintenance Daily checks:** Page 58-59
 - **Maintenance Six-monthly checks:** Page 60-62



Please read this instruction booklet fully prior to use and keep for future reference. Please pay particular attention to warnings listed on the next four pages. Failure to do so may cause severe injury or death to the user or the caregiver.



WEIGHT LIMIT

Overloading the Discovery Seat may damage the product or it may cause the Shuttle Discovery to tip over causing severe injury to the user and/or caregiver.

- Maximum loading for the Verve Stroller is 55 kg (121 lb) and the Verve Stroller storage basket is 5 kg (11 lb) (without Critical Care Basket Insert).
- Maximum loading for the Discovery Seat is 25 kg (55 lb).
- Maximum loading for the Hi-Lo Base is 50 kg (110 lb).



UNDERSTANDING YOUR SHUTTLE DISCOVERY

- The Shuttle Discovery must only be used on a level / even surface, such as concrete, asphalt, indoor floors and carpet.
- The Shuttle Discovery is not suitable for jogging / running. Sudden stopping can tip over the stroller causing severe injury to the user and /or others.
- The caregiver should be familiar with the operation of the Shuttle Discovery.



ADJUSTING YOUR SHUTTLE DISCOVERY

- Only use parts / accessories approved by Medifab.
- Please request a regular product review from the user's health care provider to ensure the Shuttle Discovery meets the changing needs of the user.
- After making any adjustments, ensure that all fasteners / knobs loosened are firmly tightened again.
- Make sure children are clear of moving parts when folding or erecting the stroller, or while making adjustments.



BEFORE USING DISCOVERY - SAFETY CHECKS

- Check that the Shuttle Discovery is fully unfolded / locked and the seat is securely mounted and the wheels are locked.
- Check that the rear and front wheels are fully engaged and secure. If the wheels are not secure, the Shuttle Discovery can tip over causing severe injury to the user.
- Check that the Shuttle Discovery is moving smoothly and functioning correctly. Any unusual noise or vibration or movement in the product could be caused by loose fasteners or damage to the product. Contact the Shuttle Discovery distributor or Medifab who will assist you to correct any problems.
- Do not use the product until the problem is rectified.



USING YOUR DISCOVERY

- Practice transfers until you are confident that you can do it safely.
- Always engage parking brakes before transferring the user in or out of the product.
- Secure the user with all the straps provided as soon as the transfer is complete.
- Ensure the straps are adjusted for the user and for changes of clothing. Ensure the straps are fitted under the pelvic support and fitted snugly to ensure correct posture and safety.
- Never leave the user unattended in the Shuttle Discovery, even for the shortest time.
- Before setting off, ensure the user is comfortable and that clothes, blankets, etc. are tucked in so they do not catch on the wheels.
- A responsible caregiver of adequate strength must propel and supervise the Shuttle Discovery during use.
- Do not allow the user to climb unassisted into the Shuttle Discovery.



OUT AND ABOUT OBSTACLES

- Take note of how the user wishes to move or be moved. Cooperation between caregiver and user will reduce the risk of injury occurring during lifting and manoeuvring operations.
- Discovery should not be used on slopes steeper than 10%.
- When using the Shuttle Discovery on a slope ensure the Discovery Seat is in an upright position and the backrest is not reclined.
- Do not apply the brakes to slow down the Shuttle Discovery. The sudden stop could cause the Shuttle Discovery to tip and injure the user.
- Hold on to the Shuttle Discovery when close to moving road vehicles, trains or strong winds. Even with the parking brake on, the draught from a moving vehicle or wind may move the Shuttle Discovery. Use the SAFETY WRIST STRAP in all of these situations and while going down slopes.



- Exercise caution when mounting and dismounting curbs.
 - To descend a curb turn the Shuttle Discovery around so that you are standing behind it. While looking over your shoulder, lower the rear wheels onto the lower ground. Carefully pull the Shuttle Discovery back and gently lower the front wheels onto the ground.

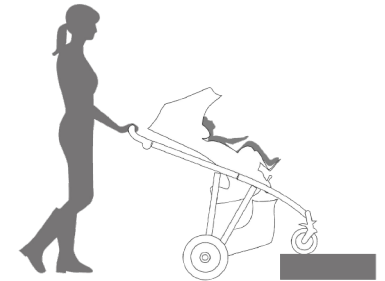

To climb a curb, approach the curb and gently tilt the Shuttle Discovery back onto the rear wheel until the front wheels clear the curb. Gently lower the front wheels down onto the higher ground and carefully lift the rear wheels onto the higher ground.

To clear obstacles such as steps and curbs, tilt the Shuttle Discovery onto the rear wheels (pull it backwards to go up; to descend, slowly lower it forward).

- Use the tipping aid as shown **(A)** to tilt the Shuttle Discovery where required.
- Do not attempt to take the Shuttle Discovery up or down a flight of steps unless you have a helper and are sure you can take the weight. When climbing the stairs always have the Shuttle Discovery and the user facing backwards. When descending the stairs always have the Shuttle Discovery and the user facing forwards.
- Lifting the Shuttle Discovery with the user is at least a two person operation. Always lift the Verve Stroller by the handle and lower frame. Do not lift by holding onto any part of the Discovery Seat, footrest, tray or the wheels. The tray should be removed and check that the user is secure and all straps are attached before attempting to lift. Do not lift by the bumper bar. It may disengage.
- Remove the user when ascending or descending escalators. Never use the Shuttle Discovery on an escalator.
- Always apply the parking brake when the Shuttle Discovery is stationary. Never use the parking brakes to slow the Shuttle Discovery down.
- Bags and other items must not be hung from the handles.
- Do not allow children to push the Shuttle Discovery.





CENTRE OF GRAVITY

- Please be aware of the factors listed below which may have an impact on the centre of gravity. Failure to observe these points may cause the Shuttle Discovery to tip over and injure the user.
- Do not exceed the Shuttle Discovery maximum load weight of 55 kg (121 lb).
- Take extra care when using the Shuttle Discovery on a slope or when negotiating obstacles. Always keep the seat and backrest upright when using on a slope.
- Be observant and mindful of your surroundings, as sudden impact with obstacles may tip the Shuttle Discovery over.
- Never park the Shuttle Discovery on a slope.
- Do not hang bags on the push handle. Use the basket under the seat.
- Do not let children play with or hang / stand on the Shuttle Discovery or other indoor bases.
- Do not let the user rise up from the seat or reach / lean left or right to reach for an object.
- Do not stand on the footplate or allow the user to transfer unaided to the Shuttle Discovery.



DISCOVERY COMPONENTS & ACCESSORIES

- Ensure the user always wears a correctly fitted and adjusted pelvic strap and shoulder harness.
- The caregiver must know how to fit, adjust and release the buckles and clips on pelvic belts, harness and jackets.
- Do not stand on the footrest.
- Always ensure that the back of the Discovery Seat is held to provide additional security and control when adjusting the backrest angle or when using the tilt in space feature.
- Ensure castors are always locked when the Shuttle Discovery is stationary.
- When using the pelvic strap or jacket, ensure the position of the harness is anatomically correct. Ensure the pad is not impeding on the throat.
- Small parts if loose will be a potential hazard for small children.



MAINTENANCE

- Shuttle Discovery requires regular maintenance by the caregiver. Daily basic check-ups must be performed before each use. A thorough six-month check of the Shuttle Discovery must be performed by the caregiver or authorised Medifab distributor. Only original spare parts should be used for repair.



TRANSPORTATION / MOTOR VEHICLE SAFETY

- Shuttle Discovery has been tested in accordance with ISO 7176-19 Wheelchairs - Part 19: Wheeled mobility devices for use as seats in motor vehicles.
- Do not use the sibling seat for transporting a second child.
- Never use the Discovery Seat as a car seat.
- Transfer the user to the vehicle seat and use the vehicle-manufacturer-installed restraint systems whenever it is feasible.
- When using the Shuttle Discovery for transit the plastic tray accessory must be removed from the Discovery Seat.
- Postural management pelvic belts and chest harnesses are NOT motor vehicle occupant restraints. Please refer to the section *Using Shuttle Discovery for Transportation in Motor vehicles* for further details and guidance.
- Always secure the seat tilt in space and the backrest recline using the RED safety plungers provided.
- An unoccupied Shuttle Discovery must be secured when being transported in the vehicle.
- Do NOT use the Shuttle Discovery (seat or stroller) if it has been involved in a motor vehicle accident.



OTHER WARNINGS AND PRECAUTIONS

- The caregiver must take precautions against fire risks. In all buildings, check the location of fire exits and ensure procedures are understood. Do not use the Shuttle Discovery near a fire or exposed flame.
- Keep the Shuttle Discovery away from sources of heat such as flames, cigarettes, open fires, heaters, radiators, etc.
- Clean and dry your Shuttle Discovery if wet
- Take care when folding or unfolding the Verve Stroller to prevent your fingers being entrapped.
- Only use the Shuttle Discovery at a normal / steady walking speed. Do not let go of the stroller while pushing it. Use the safety hand strap provided, as shown right.
- For pneumatic tyres only: Do not over inflate your Verve Stroller tyres. Manually inflate to 20-22 psi (1.5 Bars).



WARNING! Always make sure that the red seat release knobs are properly engaged at all times when the Discovery Seat is being used in any bases.



WARNING! Do not leave the user exposed to the sun. The canopy / sunhood on this product will not give the user protection from the harmful rays of the sun.



WARNING! Never leave the user unattended in the Shuttle Discovery, even for the shortest time.

Unpacking your Verve Stroller

Remove all the packaging and check you have received all the parts you ordered.

WARNING!

Ensure children do not play with packaging material, especially the plastic bags.



Unfolding Verve Stroller



Lift the frame lock levers **(A)** located on either side of the frame.

Press the push handle angle adjuster buttons **(B)** to straighten the push handle up.

Release the storage latch **(C)** to free the lower frame.

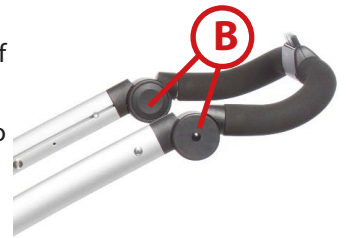

Locking Verve Stroller

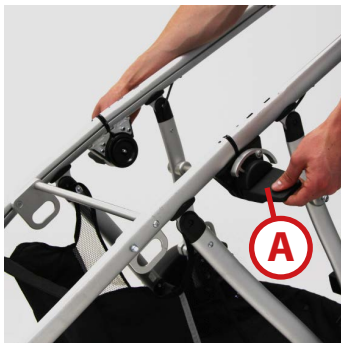

Extend the frame fully, the secondary safety lock lever **(D)** will self-lock once the frame is in an open position.

Push down the release levers **(A)** to completely lock the frame.



Installing Rear Wheels



Slide the plastic mud guard **(E)** onto the frame.

Secure the quick release pin **(F)** in the rear wheel to the frame.

Check the wheels are correctly fitted by trying to pull them out again. The rear wheels can be removed for more compact storage. Do this by pressing the centre of the quick release pin **(F)** and remove the wheels.

NOTE: For pneumatic tyres only: Pneumatic rear tyres can be inflated with a manual pump to maximum inflation pressure of (20-22 psi) 1.5 bar.



Installing the Front Wheels



Press the locking pin **(G)** in and slide the front wheels into the front frame.



1. Occipital support headrest pad
2. Padded shoulder strap
3. Thoracic laterals
4. Backrest laterals
5. Hip supports
6. Seat cushion
7. Seat release knob
8. Elevated footplate
9. Seat tilt in space
10. Tray receiver
11. Sunhood receiver
12. Headrest support wings (exterior)

Unpacking your Discovery Seat

Remove all the packaging and check that you have received all the parts you ordered.

Tools required to adjust your Shuttle Discovery are a 10mm ring spanner/socket and 4mm hex allen key.



WARNING

Ensure children do not play with packaging material, especially the plastic bags.



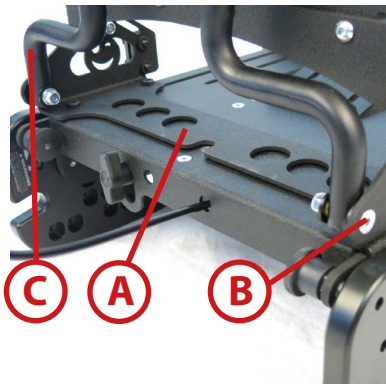

Assembling the backrest

Lift the backrest up until the hole in the backrest rear cross tube **(C)** lines up with the hole in seat depth bracket **(A)**.

Slide the brass bush into the hole in the backrest rear cross tube **(C)**. Place the large plastic washer between the cross tube **(C)** and the seat depth bracket **(A)**.

Now insert the countersink screw **(B)** into the brass bush in the rear cross tube **(C)** through the seat depth bracket and large black plastic washer **(D)**.

Secure the assembly by sliding onto the countersink screw a plain washer **(F)** followed by a nyloc nut **(G)**. Using a 4mm hex allen key and a 10mm ring spanner/socket tighten the assembly.

NOTE:

Ensure the assembly is tight and the countersink screw threads **(B)** have penetrated through the plastic ring on the nyloc nut **(D)**. Ensure thread is visible past the nyloc ring.

Follow the same procedure to secure the opposite side of the backrest rear tube to the seat depth bracket.

Ensure both pivot points assembled are not overtightened and the backrest can still be angled smoothly.

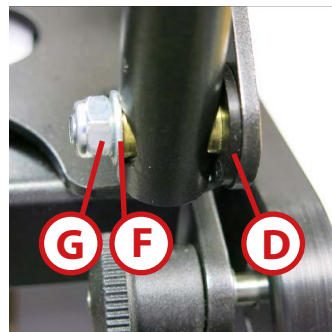
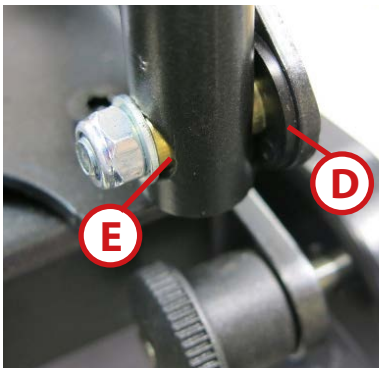

Attaching the hip supports

Secure the hip support to the seat depth bracket **(B)** with bolts **(H)**.

Follow the same procedure to secure the opposite hip support.



Attaching the thoracic laterals

Raise the backrest height (see Page 21) and lift the backrest foam out of the way (if attached). Place the two plastic washers (B) onto the thread of the clamping plate (A), insert the clamping plate into the slots.

Slide the thoracic height bracket (C) onto the exposed threads.

Secure the lower thread with a metal washer (D) and lightly tighten the nut (G) with a ring spanner/socket. Secure the top thread with a metal washer (D) and the knob (E).

Ensure the thoracic height bracket (C) slides up and down smoothly. (The bracket height is set using the knob (E).)

Secure the thoracic pad to the thoracic bracket (C) with screws (F).

Follow the same procedure to secure the opposite thoracic lateral.

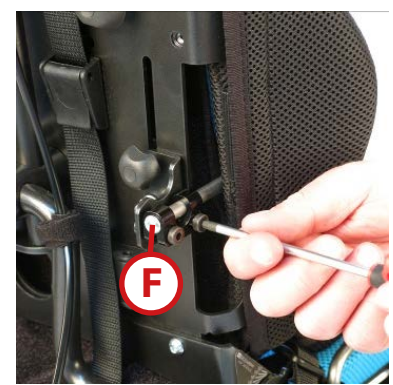
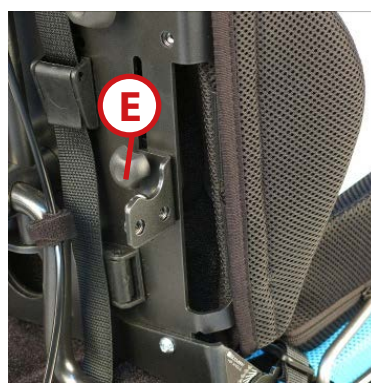
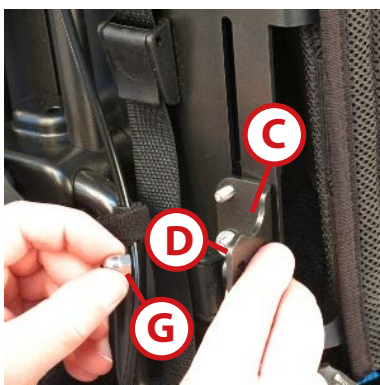

Attaching the footplate over hanging padding

Attach the over-hanging padding to the front edge of the seat using the Velcro.

Attaching the seat padding

Secure the padding to the seat base and rear of the seat base using the Velcro.



NOTE:

Ensure the Velcro on the seat base and padding is regularly cleaned (refer page 57).



Attaching the backrest padding

Hook the top of the backrest padding over the top and shoulders of the metal backrest. Tuck the lower half of the padding under the backrest.



Attaching the backrest side padding

Slide the backrest side padding over the metal backrest laterals. Secure the padding with the Velcro attached to the padding and the metal backrest.



Attaching the Occipital Headrest

Attach the Velcro at the back of the occipital headrest to the backrest padding.



Adjusting the headrest

If the headrest pushes the user's head forward, you can remove the 'LEAF' of foam from the headrest.

To do this, un-zip the upholstery cover and remove the foam inner.

Tear off the leaf and slip the cover back on. Finally, zip the cover closed.

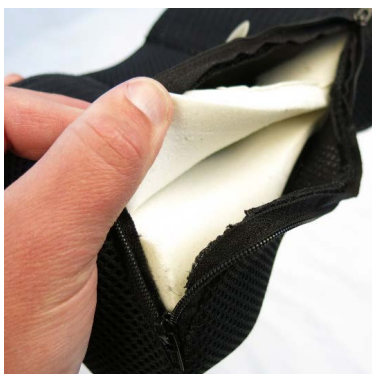

The prescriber or caregiver has the responsibility to be aware of all the available adjustments, and ensure the product is correctly set up to meet the user's needs.

Medifab recommends that a formal written record is maintained for all of the setups and maintenance checks. A product log form is available at the end of this manual.

Before placing the user in the seat, ensure the following adjustments are made. If the caregiver has any questions or if additional information is required, contact the user's health care provider or Medifab.

1. Seat depth
2. Seat width
3. Backrest height
4. Footplate height

Tools required to adjust your Shuttle Discovery are a 10mm ring spanner/socket and 4mm hex allen key.



Seat Depth

Remove or push aside the seat padding to reveal the four screws (**A**) located on the seat base.

Undo the four screws (**A**) by a few turns with the hex allen key. Once the seat depth bracket (**B**) is free, position the bracket to achieve the desired seat depth.

Secure the four screws tightly.



NOTE:

Ensure the assembly is tight. Do not adjust the seat depth while the user is seated in the seat.

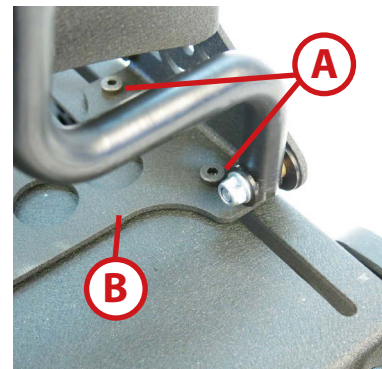

Hip guide / Seat width

Loosen the two screws **(A)** and two bolts **(B)** by a few turns. Now the hip guide width, depth and angle can be adjusted. Once an optimum position is attained retighten the screws and bolts.

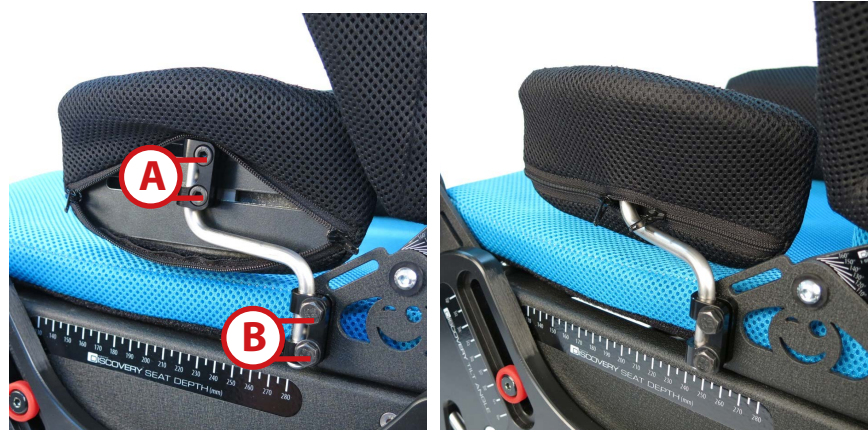

NOTE:

Ensure both hip guides are central to the backrest to align the user's pelvis correctly.

Backrest angle

Loosen the hand knob **(B)** and pull the red safety plunger **(A)** to free the backrest. Whilst pulling the plunger, angle the backrest to the desired angle. Release the plunger and secure the hand knob **(B)**.

To place the backrest in the 90° upright position release the hand knob and pull the red plunger.

Raise the backrest to 90° to the seat and release red plunger **(A)** and secure the hand knob **(B)**.

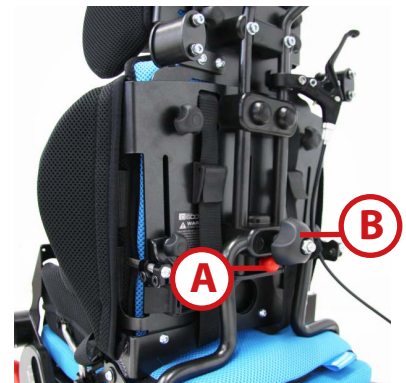

WARNINGS

1. Ensure the safety red plunger **(A)** is always engaged when the backrest is at a 90°, upright position.
2. Always hold the backrest securely at all times when adjusting the backrest angle.
3. Always check the hand knob **(B)** is tight before transferring the user into the Discovery Seat.
4. Only loosen the hand knob by a few turns and never apply excessive force to undo the hand knob as this may cause the hand knob to jam.



Transportation

When using the Shuttle Discovery for transportation in motor vehicles it is vital that the Discovery Seat backrest is secured in an upright position.

To lock the backrest

Position the backrest 90 degrees to the seat. The red safety plunger **(A)** should self-lock in this position. Check the plunger is engaged and then tighten the hand knob **(B)**.



WARNING

Failure to lock the backrest in an upright position will allow the backrest to move and in the event of an accident may cause severe injury or death to user or to other persons.

Backrest height

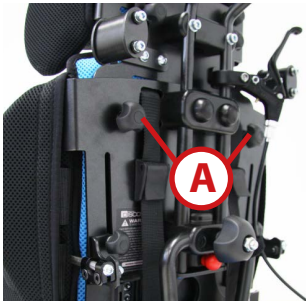

Loosen the two knobs **(A)** by a few turns. Gently pull the inner backrest up by the handle. Once the desired height has been reached tighten the two knobs.



WARNING

Ensure the knobs are tight after adjustment.

Footplate height



Loosen the two screws **(B)** by a few turns with the hex allen key. Position the footplate at the desired height and tighten the screws.

The lower footplate can be rotated upside down should you want to further reduce the seat to footplate measurement.



WARNINGS

1. Ensure the footplate is securely tightened at all times. Should the footplate fail to provide support for the feet, there is the possibility that the user may slide down the seat causing asphyxiation by the pelvis straps, jacket or the 5 point harness.
2. The footplate on the Discovery Seat is not designed to take the user's weight. Take extra care when transferring the user into the seat. Do not stand on the foot plate.
3. Ensure the user's feet do not get stuck behind the footplate.



Footplate Angle

Loosen the wing knob **(C)** by a few turns until the footplate is free. Position the footplate at the desired angle and retighten the wing knob.



WARNINGS

1. Take care when angling the footplate as there could be possible finger trap.
2. Do not stand on the foot plate.



Thoracic laterals

Loosen the four screws (A) by a few turns. Now the thoracic support width, depth and angle can be adjusted. Once an optimum position is attained retighten the screws.

Further height adjustment is possible by loosening the thumb knobs (B). Once an optimum position is attained retighten the thumb knobs.

NOTE:

Ensure the thoracic supports are positioned in a way that maintains a midline trunk position.

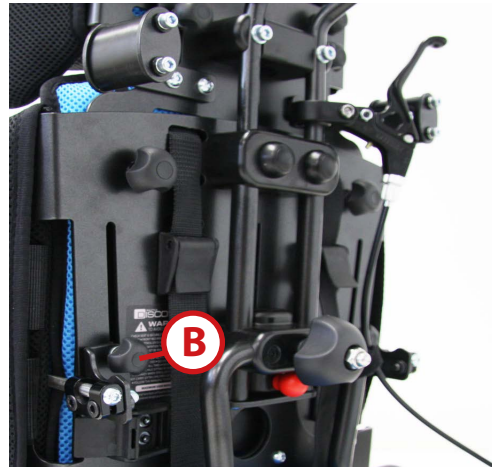

Tilt in space



Pull and rotate the safety plungers (A) to disengage the tilt locks. With the safety plungers in an 'unlocked' position hold onto the backrest handle (B) and squeeze the lever (C) and angle the seat insert to the desired angle.

To lock the angle, release the lever (C).

Upright position

Squeeze the lever (C) and rotate the seat to an upright position. To re-engage safety plungers (A) pull and rotate the safety plunger so they engage.

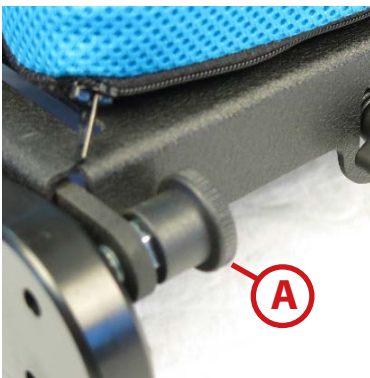

WARNINGS

1. Always hold onto the backrest handle to provide additional security and control when tilting the seat.
2. Consult with the user's health care provider for directions on how to tilt the Discovery Seat. Inappropriate seat angle may cause issues with some user's breathing or feeding.
3. Exercise caution when tilting the seat. Ensure the user's hands are not near the plastic sides as there is possibility of a finger trap.
4. When using the Discovery Seat for transportation in motor vehicles it is vital that the seat is tilted back and the safety plungers are locked. Refer image (D).

To lock the seat tilt

With the safety plungers in the 'locked' position, squeeze the tilt in space lever and tilt the complete seat until the safety plungers both engage in the lower hole. Release the lever.



WARNING

Failure to lock tilt in space safety plungers will allow the complete seat to tilt freely and in the event of an accident may cause severe injury or death to the user or other persons.

LOCKED

Swivel Lock

To swivel lock the front wheels, lift up grey lever **(A)**.

To release the swivel lock, push down grey lever **(A)**.

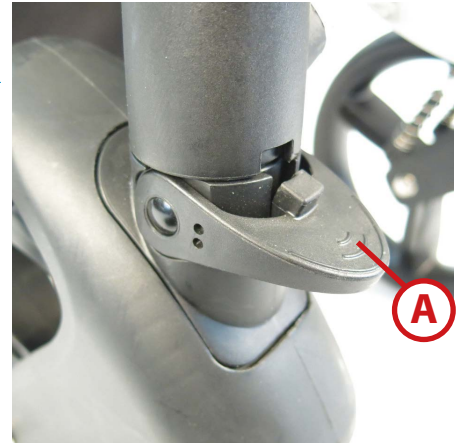

Parking Brake

To disengage the parking brake squeeze the brake tab **(B)** on the push handle.

To put brakes on: press the red button in the handle bar **(C)**.



WARNING!

Never use the parking brake to slow the Shuttle Discovery. A sudden stop could tip it over causing serious injury to the user and the caregiver.



WARNING!

Always use the parking brakes when transferring the user into the Shuttle Discovery.

Folding the Verve Stroller

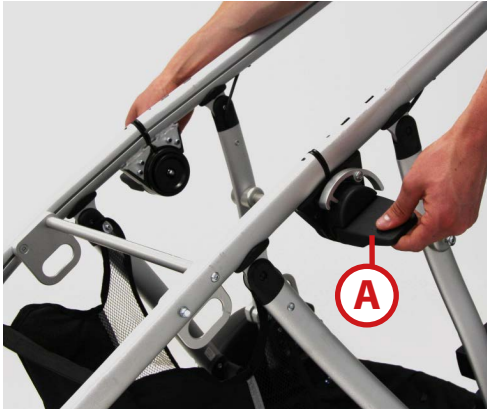

Ensure the user has been transferred out of the seat.
Ensure the sibling seat has been removed. See page 56.
Lift up the two frame lock levers **(A)** on either side of the frame.

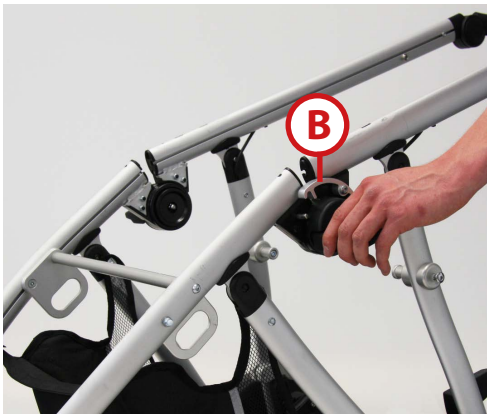

Press the safety lock lever **(B)** on the left hand side of the frame.
While keeping the safety lock lever **(B)** pressed gently push down on the push handle.



Continue pushing the push handle down until the storage latch **(C)** is engaged.

Push the frame lock lever down to lock the folded frame.



WARNING!

Take care when folding or unfolding the frame to prevent your fingers being entrapped.

Forward Facing

Before installing the Discovery Seat into the Verve Stroller, engage the parking brake.

Angle the rear of the Discovery Seat into the stroller. Slide the rear slot on the seat onto the rear mounting pegs **(A)** of the stroller.

Lower the front of the seat down onto the front mounting bar **(B)** of the stroller.

The two red safety plungers **(C)** should self-lock onto the front mounting bar. If not, press down on the front of the seat.

Ensure both safety plungers are engaged by trying to lift the seat while holding down the stroller.



WARNING

Always check that the two red safety plungers have engaged and the seat is secured before using the seat.



Rear Facing

Angle the rear of the Discovery Seat into the front of the stroller. Slide the rear slot on the seat onto the **front** mounting bar **(B)** of the stroller.

Press the front of the seat down onto the rear mounting bar of the stroller.

The two red safety plungers **(C)** should self-lock onto the rear mounting bar. If not, press down on the front of the seat.

The tray can NOT be fitted onto the Discovery Seat when the seat is in a rear facing position.



WARNINGS

1. Always check that the two red safety plungers have engaged and the seat is secured before using the seat.
2. Be aware of the length of the base and the surroundings in which the Shuttle Discovery is being used. Always use all of the positioning straps provided.



Removing the Discovery Seat

Before removing the Discovery Seat from the Shuttle Discovery engage the parking brake.

Release the red safety plungers by pulling the red knobs **(C)**. Once the front of the seat is free tilt the seat back and remove seat from the rear mounting bar.



WARNINGS

1. Always hold the Discovery Seat properly with both hands.
2. Never install or remove the Discovery Seat with the user sitting in the seat.

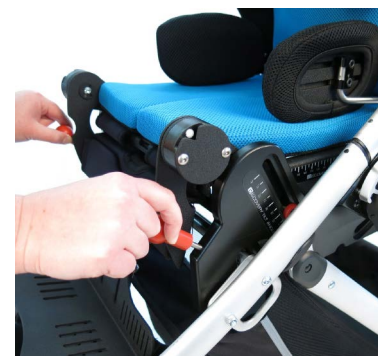



Storing in a car boot/trunk or vehicle storage area

To store your Shuttle Discovery, we recommend the following steps:

1. **Remove** the Discovery Seat from the Shuttle Discovery.
2. **Fold** the stroller.
3. **Remove** the wheels, if necessary.
4. **Angle** the footplate horizontally. **(A)**
5. **If you** require the overall length of the Discovery Seat to be shorter, the footplate angle mechanism can be detached, so that the footplate will swing up onto the seat - see below.

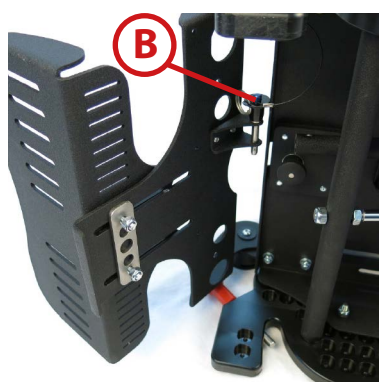

Footplate angle

Loosen the wing knob **(A)** by a few turns until the footplate angle is free.

Position the footplate horizontally and retighten the wing knob **(A)**.

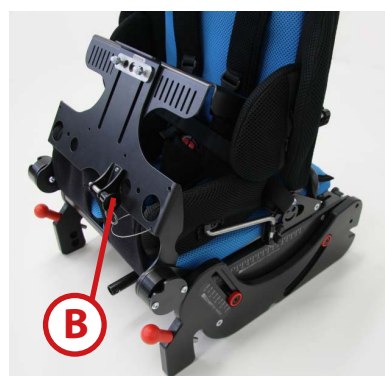

Detaching the footplate angle mechanism

Angle the footplate horizontally and remove the locking pin **(B)** by pressing the button on the pin.

Swing the footplate up until it rests onto the seat.

To re-engage the footplate, align the footplate with the angle mechanism and slide the locking pin **(B)** back into the footplate whilst pressing the button on the pin.



WARNING

Use caution when adjusting the angle of the footplate to avoid possible pinch points of the fingers.

Warnings



WARNING

Position the Shuttle Discovery and the Discovery Seat forward-facing when used as a seat in a motor vehicle.



WARNING

Transfer the user to the vehicle seat and use the vehicle-manufacturer-installed restraint systems whenever it is feasible. Store the unoccupied Shuttle Discovery in the trunk or secure it in the vehicle during travel.



WARNING

Use both pelvic and shoulder-belt restraints to reduce the possibility of head and chest impacts with vehicle components in the event of a vehicle collision.



WARNING

Remove and secure the tray separately in the vehicle to reduce the potential for injury to the user.



WARNING

Do not rely on postural supports for user restraint in a moving vehicle. Refer to image and pelvic-belt restraint use.



WARNING

Do not use the Shuttle Discovery following involvement in any type of vehicle collision.

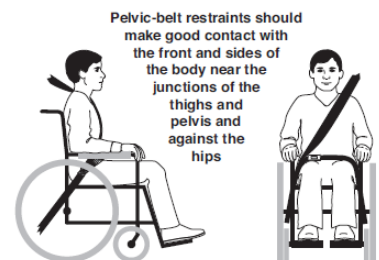

WARNING

Do not make any alterations or substitutions to the Verve Stroller securement points or to the frame.



WARNING

Take care when applying the occupant restraint to position the seatbelt buckle so that the release button will not be in contact with the Discovery Seat components during a crash.



WARNING

The maximum seat loading of 25 kg (55 lb) must not be exceeded.

Securing Shuttle Discovery for Transport



Take note of the location of the front (A) and rear (B) securement points on the Shuttle Discovery. The points are also clearly marked by a transit point label.



WARNING

Only use 4-point strap-type tie down systems approved according to ISO 10542-2. Only use wheelchair tie down and occupant-restraint systems labelled as ISO 10542-1 tested or compliant.

Attach the 4-point wheelchair tie down straps in accordance to strap manufacturer's instructions.

The angle of the pelvic belt should be within the preferred zone of 45 to 75 degrees to the horizontal, or within the optional zone of 30 to 45 degrees to the horizontal.

The pelvic belt should be worn low across the front of the pelvis. Position upper torso belts over the shoulders. The belt(s) should not be held away from the body by Shuttle Discovery parts. Ensure that the belts are not twisted.

Attach all occupant restraints in accordance with the manufacturer's instructions. Sufficient forward and rearward clear space should be provided around the wheelchair occupant.

The image on the left shows the following:

The rear clear zone is measured from the rearmost point on an occupant's head. The front clear zone (FCZ) is measured from the front most point on an occupant's head. Seated head height (HHT) ranges from about 1200mm (47 inches) for a small female to about 1550mm (61 inches) for a tall male.

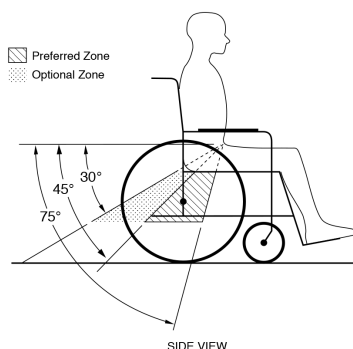

FCZ = 650mm (25.5 inches) with upper torso restraint
= 950mm (37.5 inches) with only pelvic restraint

Both pelvic and upper-torso belts must be used.



WARNING

1. **Only use the Shuttle Discovery with Verve Stroller (with fitted securement brackets)** for vehicle transportation. See Page 18.
2. **Do not use the Discovery Seat with any other base** for transportation purposes. Only use the Verve Stroller base.
3. **Do not use the Discovery Seat** as a car seat.
4. **The Shuttle Discovery basket must be empty** prior to use in vehicle transportation.

Securement latch brackets

This page is relevant to all countries outside the United States of America. Fitting the securement latch brackets must be installed by a competent technician.

In the U.S. these brackets only come pre-installed.

Front securement bracket installation

Remove the securement plate spacer and replace with the securement plate (D).

- (A) Front mounting bar
- (B) Button head cap screw
- (C) Front frame spacer
- (D) Front securement plate
- (E) Countersunk screw
- (F) Flat washer
- (G) Hexagon domed cap nut

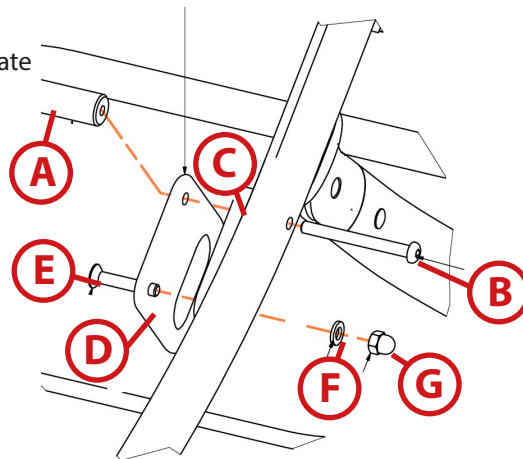

Ensure all the fasteners are torqued to 5 Nm (44 lb-in) once installed.

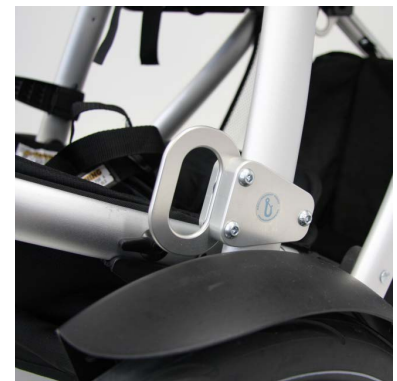

Rear securement bracket installation

- (H) Verve Stroller rear securement plate
- (I) Button head screw - 30mm
- (J) Button head screws - 25mm
- (K) Verve Stroller Rear Inner clamp
- (L) Verve Stroller Rear Outer clamp

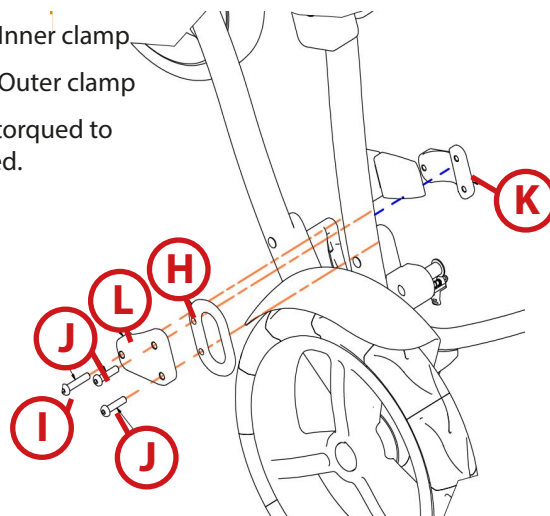

Ensure all the fasteners are torqued to 5 Nm (44 lb-in) once installed.

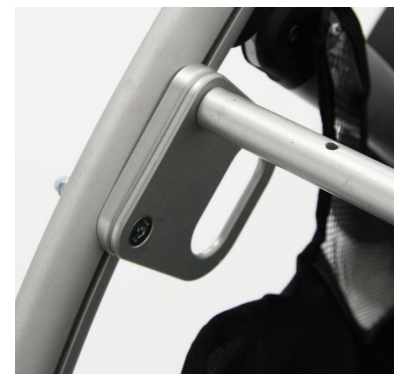

WARNING

Ensure fasteners are checked as per the 6-monthly maintenance checks. Failure to fit the securement brackets properly may cause severe injury or death to the user or to other persons in an event of an accident.

Securing the Discovery Seat for Transport

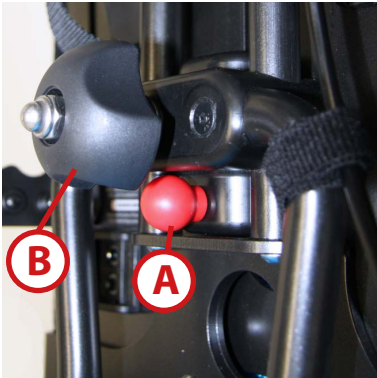

Backrest angle

When using the Discovery Seat for transportation in motor vehicles it is vital that the backrest is locked in an upright position, with the plunger engaged in the lower hole in the backrest.

To lock the backrest

Position the backrest 90 degrees to the seat by loosening the knob (B) and angling the backrest forward. Pull the plunger (A) as the backrest is being angled. Release to engage in the lower hole when the backrest is at 90 degrees.

Check the plunger is engaged and then tighten the angle adjustment knob (B).



**LOCKED
IN TRANSPORT
POSITION**



WARNING

Failure to lock the backrest in an upright position will allow the backrest to move, and in the event of an accident, may cause severe injury or death to user or to other persons.

Seat tilt in space angle

When using the Discovery Seat for transportation in motor vehicles the seat must be tilted back and the safety plungers (C) locked in the 10 degree transport holes highlighted by the warning label.

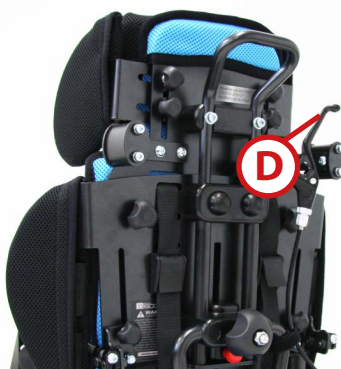

To lock the seat tilt

Pull the plungers (C), turn 30 degrees and release to engage the pins. Squeeze the tilt in space actuation lever (D) and tilt the complete seat until both safety plungers (C) engage in the lower transport hole. Release the actuation lever (D).



WARNING

Failure to lock tilt in space safety plungers will allow the complete seat to tilt freely, and in the event of an accident, may cause severe injury or death to the user or to other persons.



UNLOCKED



LOCKED

Fitting 5 Point Harness, 2 Point Pelvic Strap and 4 Point Pelvic Strap

It is advisable that each time the Discovery Seat is used, the pelvic strap is examined to ensure the strap is firmly secured and there is no visible sign of wear on the straps.

Readjust straps to allow for changes in clothing.

Pay particular attention to the following warnings relating to safe use of the 5 point harness and the 2 and 4 point pelvic straps.



WARNINGS

1. Ensure there is at least a two finger gap between the user and the pelvic straps, this will ensure the pelvic strap is not too tight.
2. Poorly fitted pelvic straps may allow the user to slide down the seat which could cause asphyxiation by the straps.
3. Check that the pelvic strap goes under the pelvic support and that it fits snugly at ALL times to maintain a correct seating position.
4. Contact Medifab and/or the user's health care provider, if you are not sure how to use the pelvic strap. Do not use, if the straps are damaged or not firmly secured.
5. Keep the straps clean, as caked-up webbing will be difficult to adjust.
6. Inspect straps frequently to ensure the straps have not worked loose.
7. Do not allow the user to undo the buckle. If the user is able to undo the buckle contact the user's health care provider for guidance on preventing the user from undoing the buckle, as this may be dangerous.

Fitting shoulder straps

Feed each of the shoulder straps through the appropriate slots in the backrest padding and the metal backrest **(A)**. Secure the straps into the two cam lock buckles situated on the backrest **(B)**.

The length of the shoulder straps can be adjusted by the two cam lock buckles **(B)**.

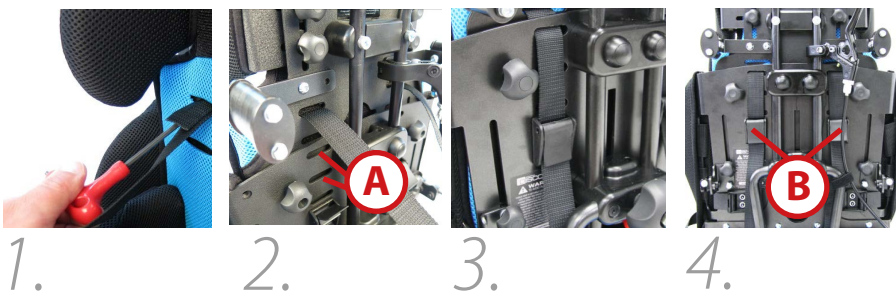

Fitting Crotch Strap

Feed the crotch strap attached to the 5 point buckle through the seat padding into the slot in the metal seat base **(C)**.

Secure the strap into the cam lock buckle **(D)** located under the metal seat base. The position of the 5 point buckle can be adjusted by the cam lock buckle **(D)**.

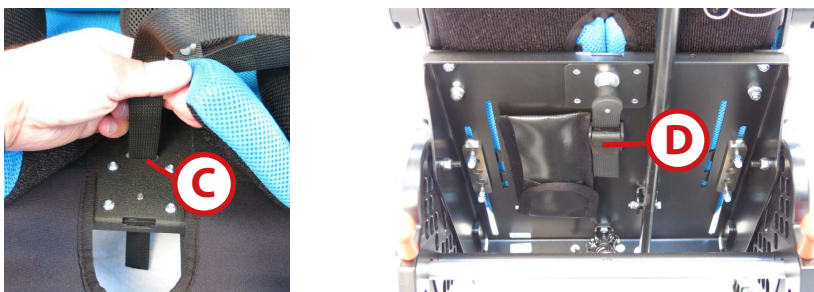

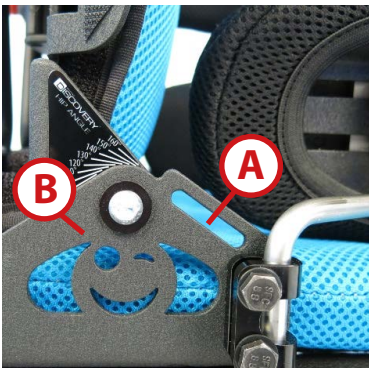

Fitting the pelvic strap

Feed the pelvic strap through the slot **(A)** in the seat depth bracket **(B)**.
Secure the straps with the triglide buckle (shown in image at right).



Triglide buckle

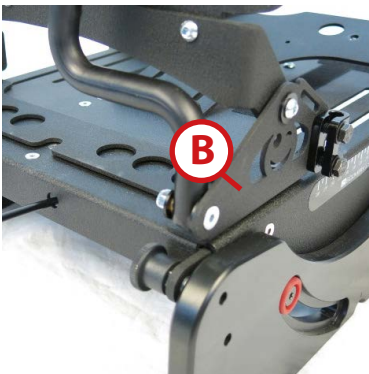

Adjusting the pelvic strap

The length of the pelvic straps can be adjusted with the triglide (shown in image at right) and the length of webbing through the slot located on the seat depth bracket.



Ensure the pelvic webbing is securely fed through the triglide as shown.



1.

2.

3.

4.



Securing the pelvic strap

Push the male and the female parts of the side release buckle together.
To release the buckle press the two slide release clips.

Securing the 5 Point Harness

UK & EU - 5point Buckle

Bring the two male parts of the buckle together and then slide the assembly into the main 5 Point buckle.

Ensure the two male buckles securely "Click" into the main buckle. To release the straps, press the red safety lock (A) first then press the 2 side buttons (B).



NZ, AU & USA

Slide the individual male buckle into the 5 point buckle. Ensure the two male buckles securely "Click" into the main buckle. It is essential that the straps are adjusted / tensioned correctly to the user and all cam lock buckles are engaged properly.

Please reference adjusting the 5 point harness section on previous page.

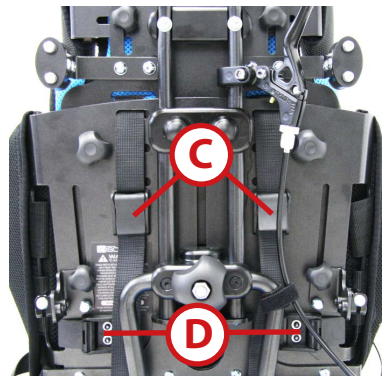
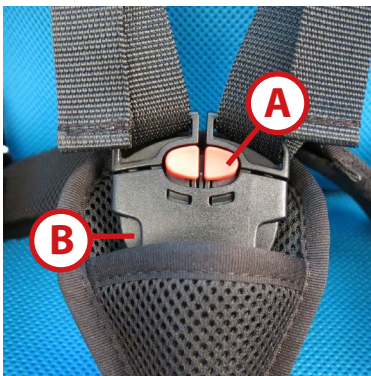

Securing the 5 point Tee-Pad Harness for infants

Feed the crotch strap attached to the tee pad through the seat padding into the slot in the metal seat base. Secure the strap into the cam-lock buckle located under the metal seat base.

Feed each of the shoulder straps through the appropriate slots in the backrest padding and the metal backrest.

Secure the straps into the two cam lock buckles (C) situated on the backrest.

Feed the pelvic strap through the slots in the seat depth bracket. Secure the straps with the triglide buckle (shown in image at right).



Centrepoint Harness X-Small

Feed each of the top shoulder straps through the appropriate slots in the backrest padding and the metal backrest.

Secure the straps into the two cam lock buckles situated on the backrest.

Secure the shoulder straps into the top cam locks (C) and the lower straps into the bottom cam locks on backrest (D).





Fitting the Jacket/Sternum harness

Feed each of the shoulder straps through the appropriate slots in the backrest padding and the metal backrest **(A)**.

Secure the shoulder straps into the two cam lock buckles **(B)** situated on the backrest.

Feed the lower straps through the side slots in the backrest into the cam lock buckle **(C)**.

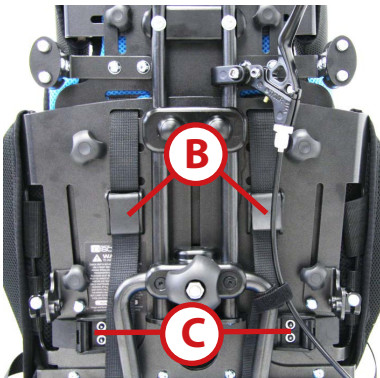

Adjusting the Harness

The length of the shoulder straps can be adjusted by the two cam lock buckles located on the back of the backrest **(C)**.

The length of the lower straps can be adjusted by the two cam lock buckles located on the back of the backrest **(B)**.

Correct harness fitting is attained when the harness fits snugly to the user's body but the caregiver's hands can be inserted between the shoulder and straps.

Securing the Jacket / Sternum Harness

Push the male buckle on the straps into the female parts of the buckles located on the jacket. To release the buckle press the release clip/ button.



WARNINGS

1. Ensure the jacket is not impeding the throat causing a choking hazard.
2. Beware of the user leaning forward or sliding down the seat, this could potentially cause asphyxiation by the jacket.
3. Always release the jacket from the shoulder straps first.
4. Ensure the jacket position and size is reviewed monthly to ensure it is correctly fitted and appropriate for the user.
5. Regularly check the jacket for wear and tear, especially the stitching on the webbing.

Fitting the bracket

Attach the two thigh strap brackets **(A)** to the seat base through the inner slot.

Place the 2 coach bolts **(B)** in the bracket and secure with the nuts and washers **(C)** under the seat base. Position the bracket as required and tighten the nuts.

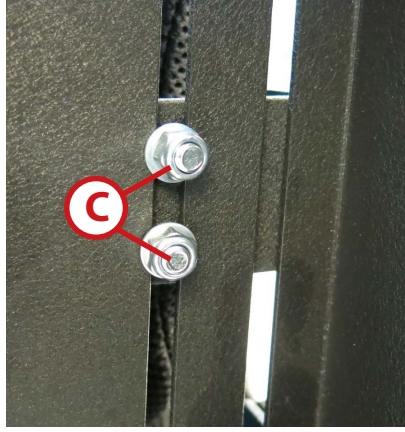
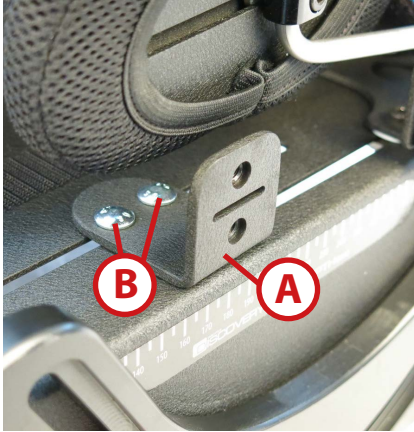

Adjusting the straps

Feed the pelvic straps through the slot **(D)** in the thigh strap brackets. Secure the straps with the triglide buckle **(E)**.

The length of the pelvic and the thigh straps can be adjusted through the triglides **(E)**. Ensure the straps are securely fed through the triglide.



1.

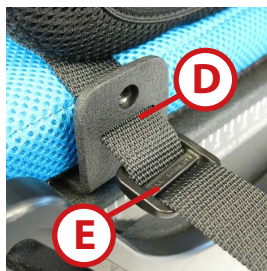

2.



3.



4.

Fitting the abduction bracket

The abduction mounting bracket consists of a slotted plate **(A)**, 4 washers **(B - underneath)**, and a plunger plate **(C)**.

Place a single screw **(D)** through the hole in the seat base, slide on the slotted plate, washer and finally tighten the screw **(D)** by a few turns into the threads in the plunger plate **(C)**. Do not tighten the screw **(D)** at this stage.

Screw in the rest of the screws **(D)** not forgetting the washer between the slotted plate **(A)** and the plunger plate **(C)**.

Once all the screws are in position tighten all the four screws.

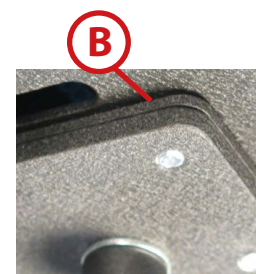
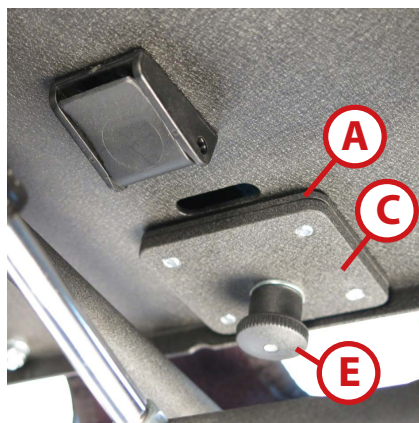

Fitting the Abduction Support

Pull the plunger **(E)** down from the front of the seat and slide the abduction support **(F)** into the bracket slot **(G)**. Release the plunger **(E)** and ensure the plunger has engaged and the abduction support **(F)** is secure.

To remove the abduction support, pull the plunger down and slide the support out.



WARNINGS

1. Exercise caution when fitting the abduction support as the footrest angling bracket may pose a risk of finger trap.
2. Ensure a safe gap is left between the user's groin and the abduction support.

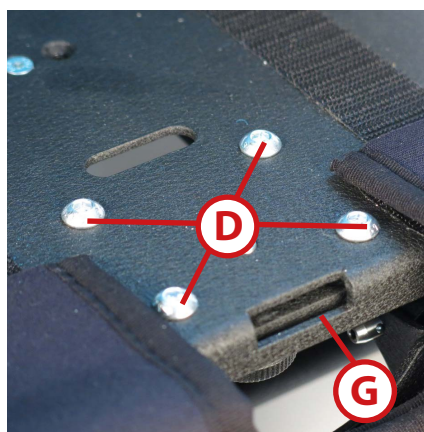

Independent Hip Guide

Attach the two brackets **(A)** to the seat base through the inner slot.

Place the 2 coach bolts **(B)** in the bracket and secure with the nuts and washers under the seat base. Position the bracket as required and tighten the nuts.

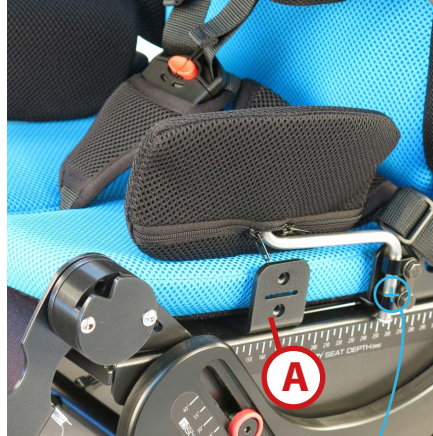
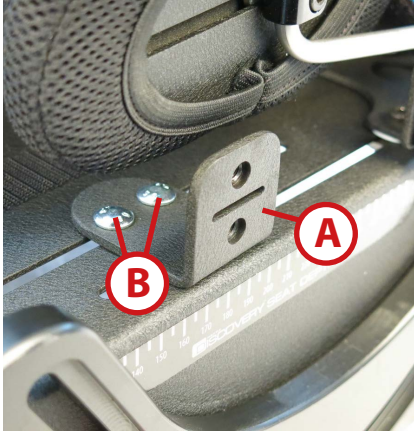

clamping
bracket

Securing the Hip Guide

Detach the hip guide from the backrest by completely undoing the bolts and re-secure it to the bracket **(A)**. Follow the same procedure for the opposite side.

Hip guide / Seat width Adjustment

Loosen the two screws **(D)** and two bolts **(C)** by a few turns. Now the hip guide width, depth and angle can be adjusted.

Once an optimum position is attained retighten the screws **(D)** and bolts **(C)**.

To adjust hip guides front to back loosen bolts **(B)**. Tighten the bolts **(B)** after adjustment.

NOTE:

Ensure both hip guides are central to the backrest

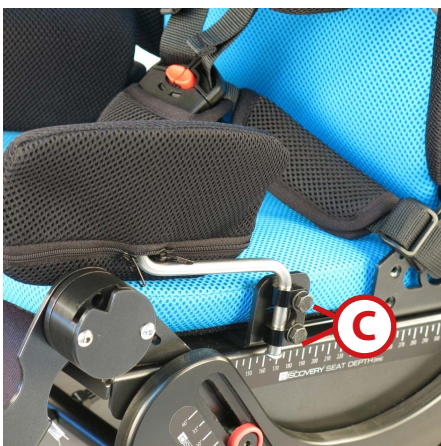



Fitting the Adduction supports

Attach the two adduction support brackets **(A)** to the seat base through the inner slot. Secure the two screws **(B)** through the slot in the seat pan into the clamping plate.

Position the support as required and tighten the screws.

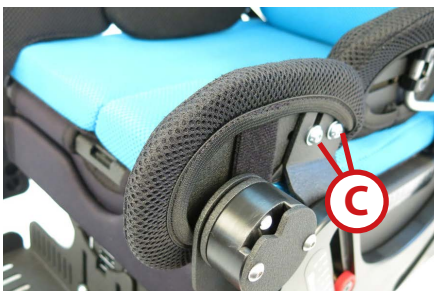

Adjusting the Adduction supports

Loosen the 2 screws **(C)** and move the support to the desired position and re-tighten.

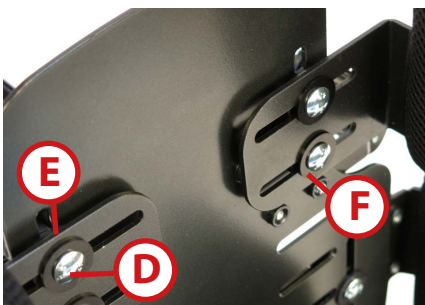

Attaching the headrest sides

Remove the backrest padding.

Using bolt **(D)**, along with washers **(F)** and **(E)**, secure the headrests to the backrest through the slots. The thick washers **(E)** are to be assembled between the headrests and the backrest.

Secure the bolt with the washer **(G)** and the knob **(H)**.

Assemble all the other 3 bolts in the same manner.



Adjusting the headrest sides

Loosen the thumb knobs **(H)** by a few turns, position the headrest side as desired and retighten the knobs.

IV and Oxygen Bottle Mounting

The mounting hardware can only be fitted on the left hand rear of the driving direction on the Verve Stroller.

Both the IV Pole and Oxygen Bottle Holder require the Mounting Bracket (A) to be fixed to the Verve Stroller.

Remove Qstraint peg (B) and M6 x 70mm cap screw (C) and replace with M6 x 75mm cap screw (D).

Loosely mount top hole in the bracket using 75mm cap screw (D) and Qstraint peg (B).

Mount lower end of the bracket using the inner and outer rear tie-down clamps (E) and (I) respectively using the M6 x 35mm button head screw on the front hole and M6 x 30mm on the rear holes.

Tighten all bolts/screws (including peg (B)) once mounted.

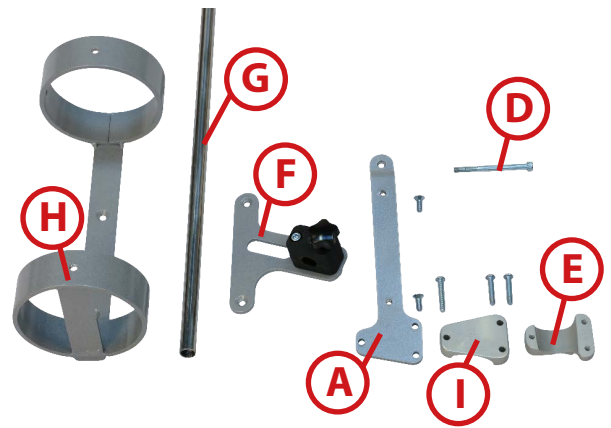

WARNINGS

Ensure all screws are tightened firmly.



IV Pole Mounting Assembly

Mount IV mounting assembly (F) to the Mounting Bracket (A) using the M6 x 10mm countersunk screws. Loosen knob on IV mounting assembly (F) and slide the IV pole (G) into the bracket, secure at the desired height by re-tightening the knob firmly by hand. Tighten countersunk screws firmly.



WARNINGS

Ensure all screws are tightened firmly.

Ensure the knob is tightened firmly to ensure the IV pole cannot slide.



Oxygen Bottle Holder Mounting Assembly

Mount Oxygen Bottle Holder (H) to the Mounting Bracket (A) using the M6 x 10mm countersunk screws. Tighten countersunk screws firmly.



WARNINGS

Ensure all screws are tightened firmly.

Ensure the knob is tightened firmly to ensure the IV pole cannot slide.



IV Pole & Oxygen Bottle Holder Mounting Assembly

If both IV Pole and Oxygen Bottle Holder are to be mounted to the Verve Stroller, fix the IV Pole mounting assembly behind the Oxygen Bottle Holder using the M6 x 15mm countersunk screws, in place of the M6 x 10mm screws.



WARNINGS

Ensure all screws are tightened firmly.

Ensure the knob is tightened firmly to ensure the IV pole cannot slide.



Thigh, Trochanter & Shoulder protraction Wedges

Fitting the Thigh Wedge

Place the thigh wedge on top of the seat pan and secure with the Velcro interface. The cushion then Velcros on top of the wedge.

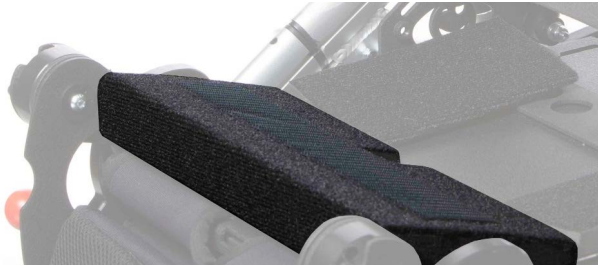

Fitting Trochanter Wedges

Place the trochanter wedges on top of the seat pan and secure with the Velcro interface. The cushion then Velcros on top of the wedges.



Fitting Shoulder Protraction wedge

Place the shoulder protraction wedges at the top of the backrest pan and secure with the Velcro interface. The backrest cushion then Velcros on top of the pad.



Fitting the Sacral Pad

Place the sacral pad at the bottom of the backrest pan and secure with the velcro interface. The backrest cushion then Velcros on top of the pad.

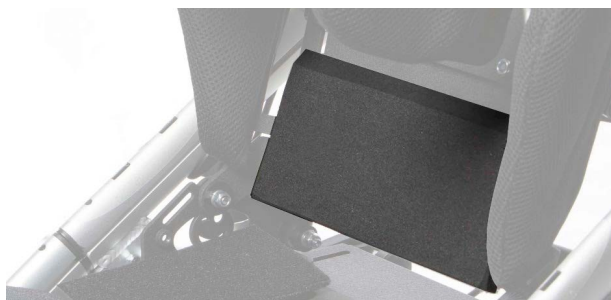

Modular Cushion

Part No. 2006-0610-0xx (xx = Colour code)

The modular cushion is designed for addressing pelvic positioning needs that are too complex to be addressed by the flat seat cushion and the wedges associated with it.

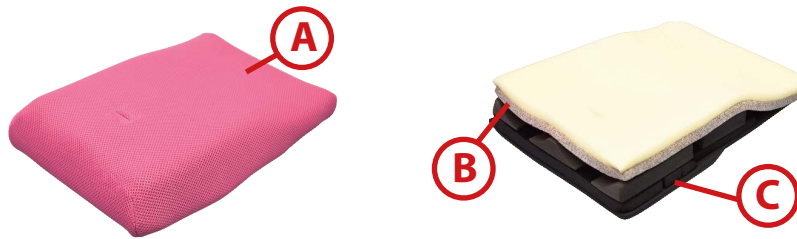

WARNING

Interfering with the modular positioning elements inside the cushion could present a risk to the user.

To configure the cushion:

1. A set of accurate user measurements should be obtained in order to set this up correctly. Measurements we recommend are as follows:
 - Seat depth / **Measurement B** (while sitting most upright / at optimum pelvic tilt)
 - Seat width / **Measurement A** (both at the hips and at the thighs)
 - Position for pre-ischial shelf / **Measurement H** (typically this is the line of the gluteal crease, measured from rear of cushion)
2. Remove the covers (**A**) and the foam overlay (**B**) from the cushion to reveal the positioning elements (**C**).
3. Configure the pre-ischial thigh support:
 - Use a combination of 20mm (0.8 inches) thick flat sections to create the required depth of support for thighs in front of the users IT / pelvic bones (Measurement H).

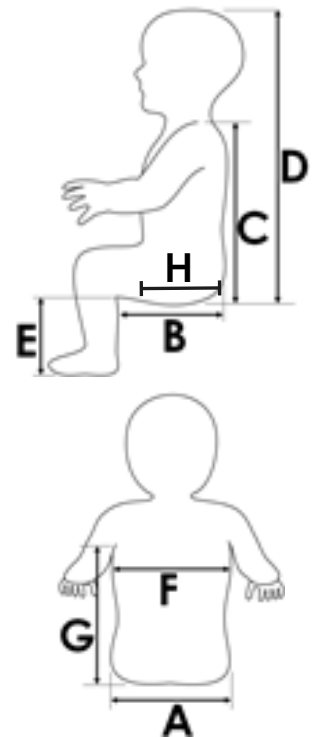

NOTE:

One of the sections has the edge rounded off (**D**). This must be used at the rear of the pre-ischial shelf against the IT pelvic bones (Measurement H).

Some sections of this element may not be required due to a short seat depth. These should be retained for introduction at a later date once the user grows.

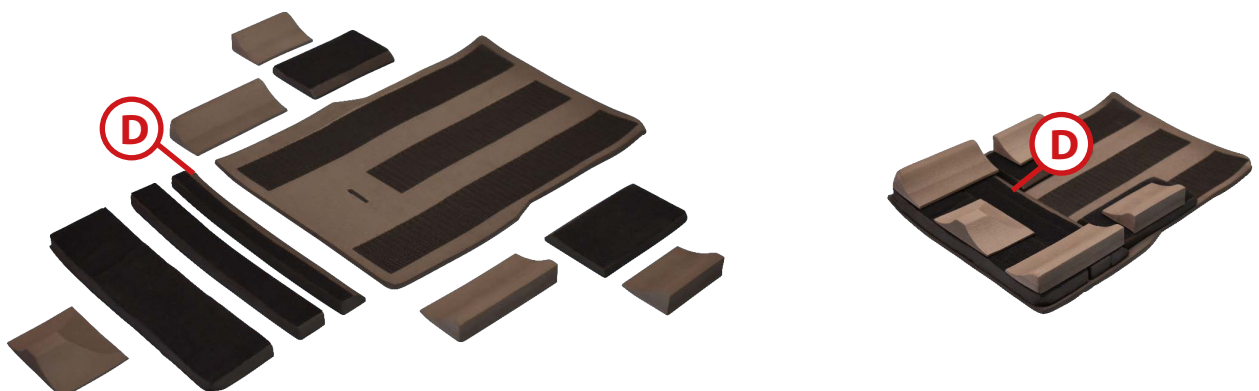

Modular Cushion

1. **Add trochanter support (head of femur) wedges (A):** these are positioned directly behind the pre-ischial shelf (Measurement H) to provide stability and a means of correction/accommodation for an uneven pelvis (pelvic obliquity). Adjust the width between these to suit the needs of the user. One may be eliminated to address uneven pelvis (pelvic obliquity) issues.
2. **Add adduction (B) and abduction (C) wedges**—IF required: In some cases these may require alteration such as narrowing of the adductor wedges (B) or abductor pommel (C). Use the shorter wedges where shorter seat depth is required (Measurement B) - these can also be cut down if required.
3. **Assemble cushion**—install foam overlay with loop fabric on underside attaching to base panel of cushion. The black wipe down cover is installed and then the breathable fabric cover (if supplied)
4. **Install onto seat frame;** ensure there is hook attachment on the seat panel to hold the cushion in place, line the front of the cushion up on the seat pan overhanging the edge by approximately 10mm (0.4 inches).
5. **Install new extended Z brackets on Hip pads;** these allow for the extra thickness of the modular cushion. Remove hip pad fasteners (D) and mounting point (E) and replace with the new extended Z bracket assembly.

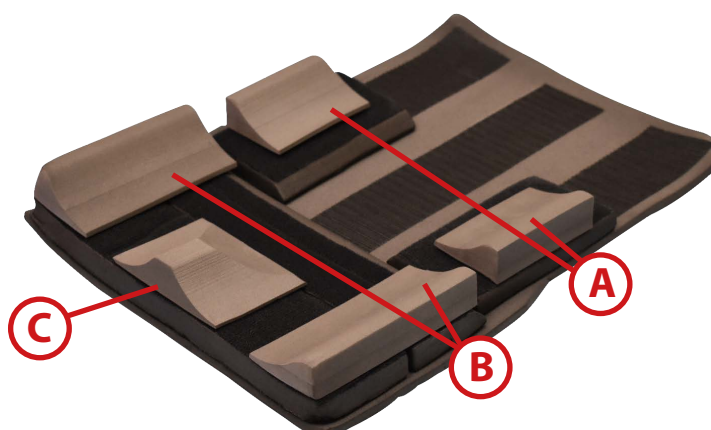

Image above shows Standard Cushion



Fitting the Tray Mounting Bracket

NOTE:

The mounting block (A) is right and left handed. The slot in the mounting block (B) should be facing towards the front.

Secure the mounting block (A) and the height stop plate (D) to the footrest hinge bracket (C) using the bolts (E).

Use a 3mm Allen key and tighten bolts (E) to 1/4 turn past finger tight.

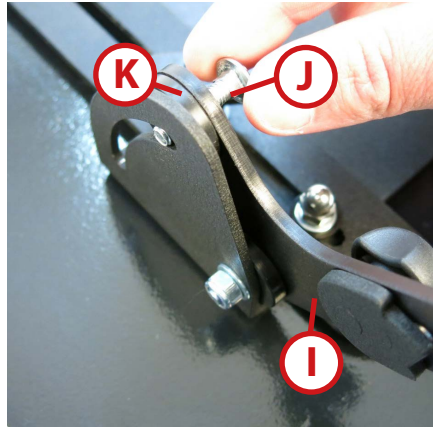
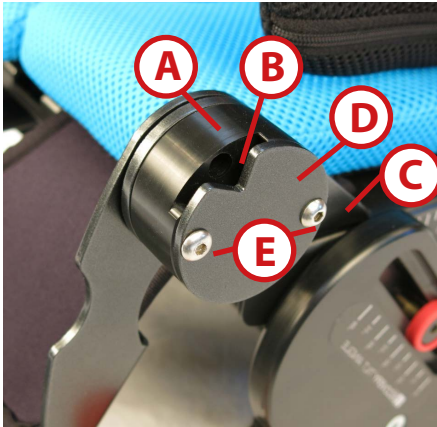

Assembling the Tray

Place the tray flat and remove the knob (F), metal washer (G) and the thin plastic washer (H).

Pull the bolt (J) out until the height adjustment leg (I) is free to rotate up. Rotate the height adjustment leg (I) until it is in line with the curved slot. Push the bolt through the slot.

Slide the thick plastic washer (K), thin plastic washer (G) and the metal washer (F) onto the bolt (J) in the order shown in the images. Secure the assembly with the knob (F).

Follow the same procedure to assemble the opposite tray height adjustment leg (I).

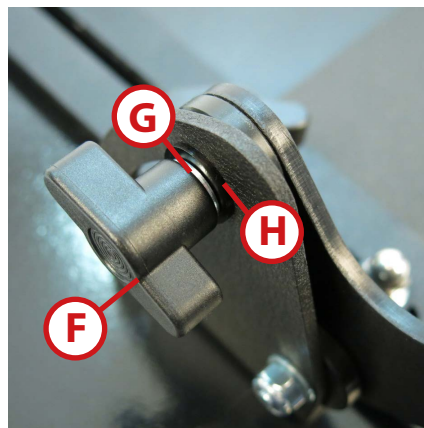
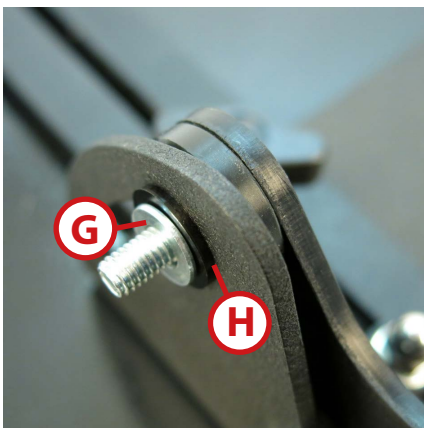

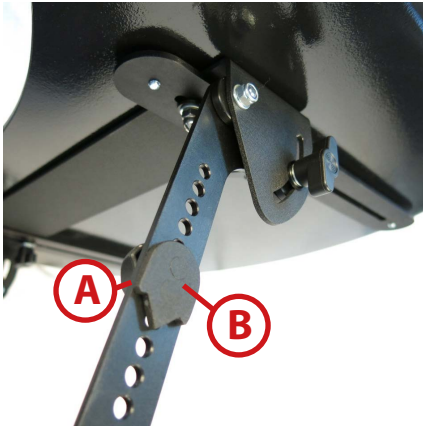

Tray Height Adjustment

Undo the thumb knob **(A)** completely. Reposition height stop **(B)** and re-secure the thumb knob **(A)** firmly.

NOTE:

Ensure the height stop is facing outwards and the thumb knob is facing inwards.

NOTE:

Ensure the height stops are positioned parallel to each other.

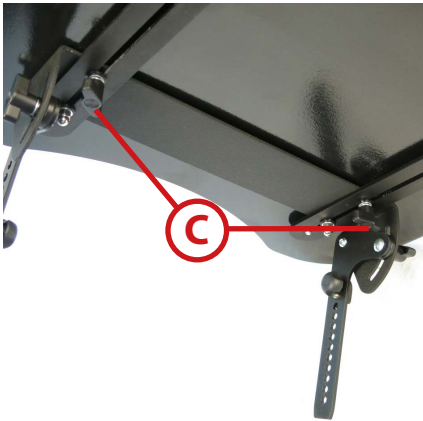

Tray Depth Adjustment

Loosen the two wing knobs **(C)** by a few turns.

Slide the tray to desired depth and retighten the knobs **(C)**.

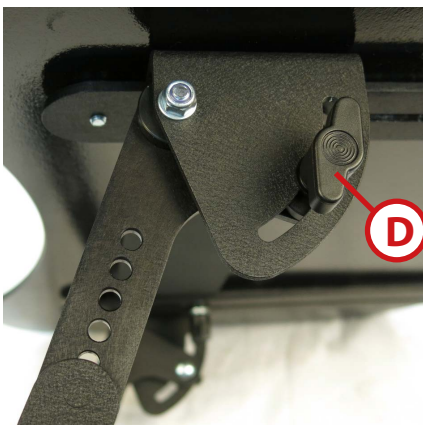

Tray Angle Adjustment

Loosen the two wing knobs **(D)** by a few turns.

Angle the tray to desired angle and retighten the knobs **(D)**.

Fitting the Tray

Slide the tray height adjustment legs (A) into the tray mounting block (B).

Ensure the tray height stops (C) are sitting into the tray stop plates (D) and that the tray is level.



WARNINGS

1. Ensure there is a small gap between the user and the tray cut out.
2. Do not fit the tray too tightly against the user's chest.
3. Ensure the user does not get their arms stuck in the tray cut out or in the sides of the stroller.
4. Do not place heavy objects on the tray.
5. Do not steer the chair by the tray.
6. Exercise caution when fitting the tray. Ensure the user's hands are raised and not near the plastic tray mountings as there is possibility of a finger trap.





Fitting the grab bar

First, unlock the release lever **(A)** then slide the grab rail on to the lip of the tray table.

Ensure the locking paddle **(B)** rotates down to enable the rail to grip the edge of the tray.

Lock the lever **(A)** into position.

Adjusting the grab bar

Unlock the release lever **(A)** then slide the grab rail to the desired grab position for the user.

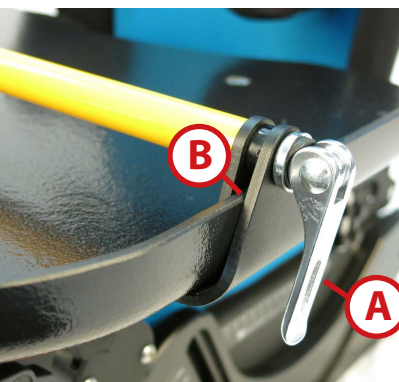

Critical Care Basket Insert

The Critical Care Basket Insert sits inside the Verve Stroller's basket. Place the hooks on rear tube **(C)** and wrap the straps over the Verve Stroller's front mounting bar **(D)**.

Secure with triglides (shown in image at right) and adjust the length of the straps to ensure the tray is level with the ground. The maximum loading for the Basket Insert is 10 kg (22 lb).



To Remove

Release buckles to detach the straps from the front mounting bar, and lift the tray out of the storage basket.



WARNINGS

1. Critical Care Basket Insert must be removed prior to transportation in a motor vehicle.
2. Do not exceed basket insert weight limit of 10 kg (22 lb)

Fitting the Toe & Ankle straps

Pass the Velcro straps through the footplate at the desired width for the user's foot. Then connect the straps together **(A)** as shown under the footplate.

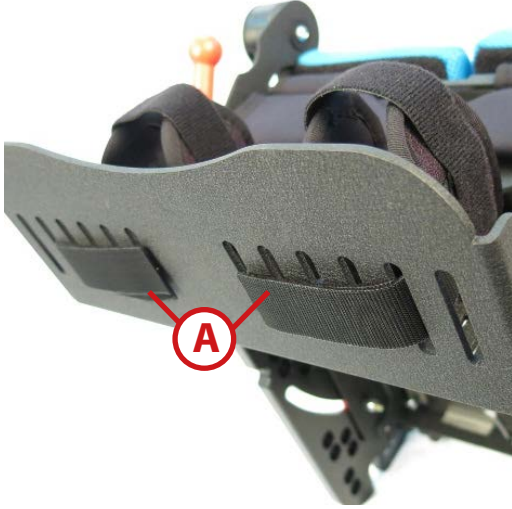

Footplate over-cover

Fit the padded footplate cover with Velcro as shown.



Footplate Dorsiflexion wedge

Fit the Dorsiflexion wedge with slope going back. i.e. with thick edge **(B)** at front and thin edge **(C)** at rear.

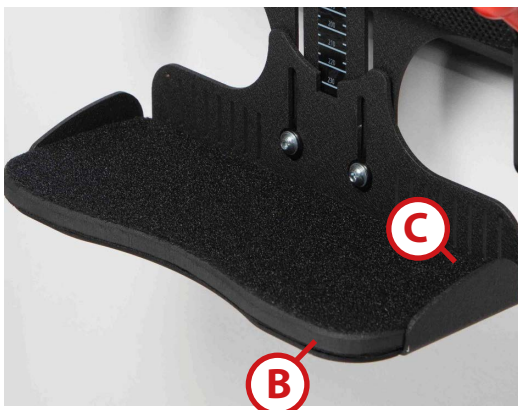

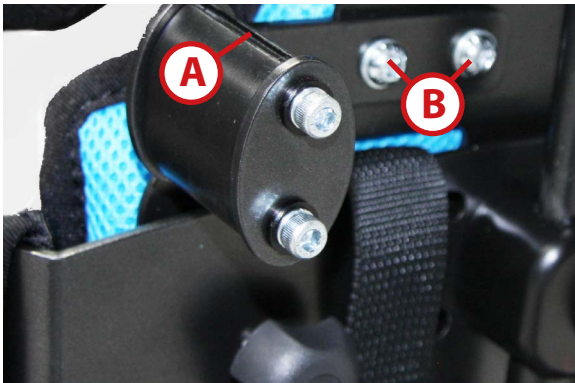

Fitting the Sunhood brackets

Fit the two Sunhood brackets to the backrest shell using the four M6 screws (**B**) and spring washers.

Ensure the groove (**A**) in the plastic is facing upwards.

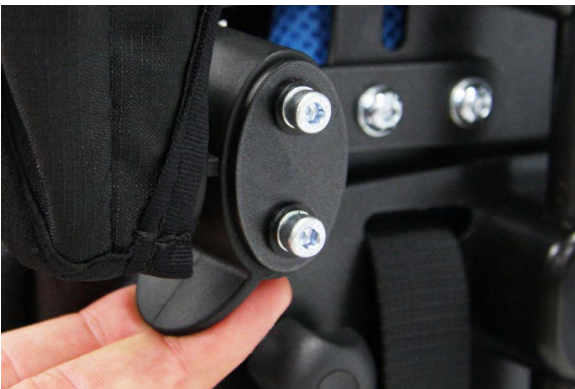

Installing the Sunhood

Mount the Sunhood clip onto the Sunhood mounting bracket with the lip (**C**) in the groove (**A**).

Ensure the clip has fully clicked in position.



Removing the Sunhood

Pull on the tab on the Sunhood clip to remove the Sunhood.



Snuggle Warmer

Remove the shoulder and crotch straps from the Shuttle Discovery, position the pelvic and thoracic guides within the lower and upper slots of the bag respectively.

Pat the bag down (removing folds/ wrinkles) to shape to the chair for optimal comfort. Feed pelvic straps through the lower slot along with the pelvic guides (**D**).

Feed the crotch strap through the central slot (**E**), determine the optimal shoulder strap height for the user and feed through the respective upper slots (**F**).

The attachment of straps to the chair does not change when using a Snuggle Warmer, see pages 32-35 for fixing straps/ harnesses to the chair.



Moon Rock Base

Installing the Discovery Seat

Before installing the Discovery Seat into the Moon Rock Base, engage the anti-rock mechanism. Angle the rear of the Discovery Seat into the Moon Rock Base. Slide the rear slot on the seat onto the rear mounting bar **(C)** of the Moon Rock Base.

Press the front of the seat down onto the front mounting bar **(D)** of the Moon Rock Base. Ensure the red locking pins **(A)** have fully engaged.



WARNINGS

1. Always check that the two red safety plungers have engaged and that the seat is secure before using the seat.
2. Be aware of the length of the base and the surrounding in which the Moon Rock Base is being used.
3. For safety reasons, the seat will only be installed one way into the base. The notch **(E)** in the seat side engages into the crossbar to ensure this.

To engage the anti-rock bars

Pull the anti-rock bars out **(B)**. The spring mechanisms will lock the bars in place.

To disengage the anti-rock bar

Push the anti-rock bars back until they have fully retracted.



WARNING

Take care when pulling/pushing the anti-rock bars as there are possible pinch points.





Removing the Discovery Seat

Before removing the Discovery Seat from the Moon Rock Base, engage the anti-rock mechanism.

Release the red safety plungers by pulling the two red knobs **(A)**. Once the front of the seat is free, tilt the seat back and remove the seat from the rear mounting bar.

Failure to follow these instructions and warnings could result in serious injury or death to the user.



WARNINGS

1. Always use all of the positioning straps provided.
2. Always hold the Discovery Seat properly with both hands. Otherwise the seat could fall and cause damage.
3. Never install or remove the Discovery Seat with the user sitting in the seat.
4. Do not allow other individuals to use, play with, stand on, ride on or run / play around the Moon Rock Base.
5. Allowing other children to play near the Moon Rock Base may cause serious injuries due to the rocking motion of the base.
6. Do not stand on the rear cross bars or aggressively rock the Moon Rock Base, as this may cause the Moon Rock Base to tip.
7. Always use the Moon Rock Base on an indoor level surface.
8. The tray is not designed to hold the user in the seat.

A-Frame Launcher Base (NZ & AU only)

To unfold the A-Frame Launcher Base, use both hands to squeeze the red levers **(B)**, slide both down until the levers both re-engage. Ensure it cannot be readjusted without squeezing the red levers **(B)**.

Never adjust the height of the A-Frame Launcher Base with the user seated in the Discovery Seat. To adjust the height, use both hands to squeeze the red levers **(C)** and slide to adjust height. Release levers and ensure both engage and lock.

For the caregiver's safety we recommend the caregiver kneel in front of the Launcher Base and maintain a straight back while adjusting the seat height.

Please ensure all warnings on Pages 52 and 54 are read and understood prior to using the A-Frame Launcher Base.



Hi-Lo Base

The Hi-Lo base can be configured with a gas spring or an electric actuator.

Locking the Castors

Lock the castors by pressing the brake **(A)** down (on each of the 4 corners) and raise the base to its maximum height.



Handle Assembly

Before mounting the Discovery Seat into the Hi-Lo base, install the handle **(B)**. Slide handle into tubing hanger until the end cap presses on the cross bar, the mounting holes should line up.

Insert screw **(C)** and screw **(D)** front and back respectively, on the underside of the base, and ensure that they are tightened to secure the handle.



Installing the Discovery Seat

Angle the rear of the Discovery Seat into the Hi-Lo base. Slide the rear slot on the seat onto the rear mounting bar of the base.

Press the front of the seat down onto the front mounting bar **(E)** of the base.

The two red safety plungers **(F)** will self-lock onto the front mounting bar.



WARNINGS

1. For safety reasons, the seat will only install one way onto the base. The notch **(G)** in the seat side engages into the crossbar to ensure this.
2. Always use all the positioning straps provided.
3. Before using the seat, always check that the two red safety plungers have engaged and that the seat is secure.
4. Be aware of the length of the base and the surroundings in which the base is being used.
5. Do not allow other individuals to use, play with, stand on, ride on or run / play around or under the base.
6. Do not allow the end user or other children to operate the electric height adjustment feature.
7. Always use the base on an indoor level surface.
8. Always lock the 4 castors **(A)** when the base is in use.
9. We recommend that a tray be used at times when using the Hi-Lo base, unless the base is being used under a table.
10. Always lock the castors before mounting the Discovery Seat into the Hi-Lo base.
11. The central mounting bracket for the actuators is very low to ground. Take care when rolling on uneven surfaces/ramps or when ascending/descending bumps as this may scrape on the surface below.

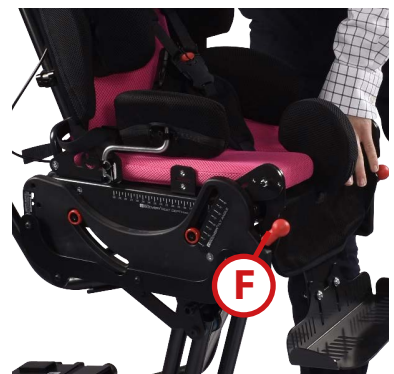



Adjusting the height - Powered Version

Plug in the handset by turning the Hi Lo base on to its side and inserting the cable lead into the control box as show.

Use the handset to adjust the height of the Hi-Lo base. The Discovery seat can be height adjusted with the user in the seat. When lowering the base, please ensure the footplate is always at least 25mm / 1" inch above the ground. Always store the handset on the push handle or away from the reach of the end user.



Before using the Powered Hi-Lo base for the first time, charge the batteries for 24 hours in order to reach proper function and prolong the life of the battery.

To charge the batteries, plug the charger into the mains and connect the charger lead into the handset. Green LED will display when charger is on, Yellow LED when charging.

When charged, switch off the mains power and remove the charger lead from the handset.

Batteries should be charged for 30 mins to an hour at the end of each day to maintain optimum life.

An audible bleep sound from the handset is a low battery warning and the batteries should be charged immediately.

Adjusting the height - Gas Assisted Version

Before adjusting the height on the gas assisted version, lock the castors all four castors as detailed above.

Raising the seat

Disengage safety plunger (A) located on the left-hand side of the foot pedal (B) by pulling the plunger head (A) and rotating by a quarter turn. This will make the foot pedal operational.

Press foot pedal whilst holding on to the push handle. Remove your foot from the pedal to lock the base at a desired height.

Depending on the weight of the user, you may have to assist with lifting the seat to the required height. Rotate the safety plunger head by quarter turn to lock the foot pedal.

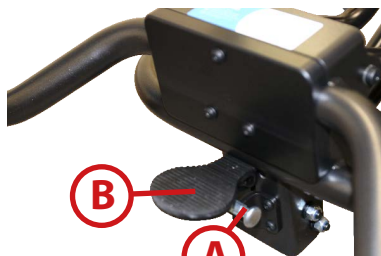

Lowering the seat

Disengage the foot pedal safety plunger. Press the foot pedal down and push down onto the push handle to lower the base.

Remove your foot from the pedal to lock the base at desired height. Rotate the safety plunger head by a quarter turn to lock the foot pedal.

To ensure smooth height adjustment of the base gently press foot pedal, hold onto the push handle and let the user know of your intension to adjust the seat height to ensure the user is not startled by sudden movement.

Always keep the foot pedal locked when not in use. Locked foot pedal will prevent accidental height adjustment.

When lowering the base ensure the footplate is always at least 25mm / 1" inch above the ground.

**WARNINGS**

1. Ensure the seat is secure and locked in the angle slot before placing the user into the seat.
2. Always lock the castors when the Hi-Lo Base is in use.
3. Care must always be taken especially when the seating is in the raised position.
4. When doing a hoist transfer, ensure that the hoist sling is not caught on any part of the Discovery seat or the base.
5. Before moving the base, ensure all brakes are released and the footrest is at least 1" / 25 mm above ground level.
6. When adjusting the Discovery seat on the Hi-Lo base under a table, ensure enough space is maintained between the user's thighs and the underside of the table. Do not leave the Hi-Lo base in direct sunlight for long periods of time.
7. When lowering the Hi-Lo base ensure the footplate does not contact the floor. If the powered base comes into contact with the floor there is a chance the front skis of the base will lift, damaging the footplate and causing injury to the user.
8. Always lock the foot pedal with the safety plunger after adjusting the height (Gas Version)
9. Always store the handset safely on the push handle after use.
10. The seat unit can only be installed facing forwards. Do not try to install facing backwards.
11. Do not use the powered base if any electrical wires are exposed or the plastic casing on the Actuator, control box, handset, mains charger are damaged.
12. Should any form of liquid come into contact with the actuator, control box, handset, charger or curly cable, thoroughly dry the components and test the system before using it. If you suspect liquid has seeped into the components or if in doubt, do not use the powered base and contact your dealer for further advice.
13. When adjusting the height of the base, ensure that there are no obstructions as there is a crushing hazard when lowering the base.
14. Electric Actuator only: Do not open any of the electronic components. Do not exceed the load cycle of 2 min. of continuous use followed by 18 min. not in use. Listen for any unusual sounds or smells, stop immediately and do not use if anything unusual is observed.

Removing the Discovery Seat

Before removing the Discovery Seat from the Hi-Lo Base, the castors must be locked.

Release the red safety plungers by pulling the red knobs (A).

Once the front of the seat is free, tilt the seat back and lift the seat from the rear mounting bar.

**WARNINGS**

1. Always hold the Discovery Seat properly with both hands. Otherwise, the seat could fall and cause damage.
2. Never install or remove the Discovery Seat with the user sitting in the seat.



Lunar Base

For safety reasons, the seat will only install one way into the base. The notch **(B)** in the seat side engages into the crossbar to ensure this.



Installing the Discovery Seat

Angle the rear of the Discovery Seat into the Lunar Base. Slide the rear slot on the seat onto the rear mounting bar of the Lunar Base.

Press the front of the seat down onto the front mounting bar **(A)** of the Lunar Base.

**WARNINGS**

1. The two red safety plungers **(C)** should self-lock onto the front mounting bar.
2. Always check that the two red safety plungers have engaged and that the seat is secure before using the seat.
3. Be aware of the length of the base and the surrounding in which the Lunar Base is being used.
4. Do not allow other individuals to use, play with, stand on, climb on or run / play around the Lunar Base.
5. Always use the Lunar Base on an indoor level surface.
6. Always use all of the positioning straps provided.

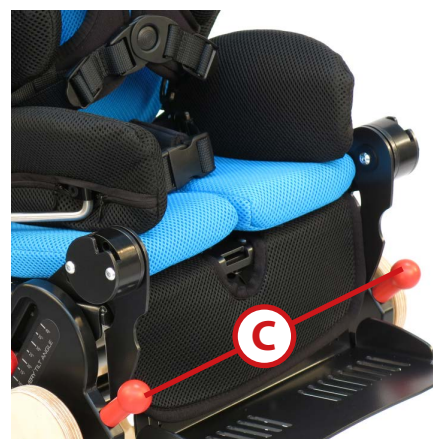

Adjusting the height

To adjust the height of the Lunar Base, remove the outer screws **(A)** whilst holding the T nuts **(B)** with the other hex allen key. Reposition the leg to the desired height and retighten the screws into the T nuts **(B)**.



WARNINGS

1. Never adjust the height of the Lunar Base with the user seated in the Discovery Seat.
2. Ensure all four legs are level and secure before placing the user into the Discovery Seat.
3. For the ease of adjustment we recommend that the height of the Lunar Base is adjusted without the Discovery Seat mounted on the Lunar Base.



Removing the Discovery Seat

Release the red safety plungers by pulling the red knobs **(C)**. Once the front of the seat is free, tilt the seat back and remove seat from the rear mounting bar.



WARNINGS

1. Always hold the Discovery Seat properly with both hands. Otherwise the seat could fall and cause damage.
2. Never install or remove the Discovery Seat with the user sitting in the seat.



Rain / UV Cover

Fit the Rain / UV covers by firstly fitting the sunhood then drape the cover over the sunhood and over the handle bar.

Attach to the frame using the Velcro loops.



Sibling Seat



WARNING

Do not exceed the maximum load capacity of 15 kg (33 lb).

Installing the sibling seat

Align the tabs under the seat to the frame and gently push down. The seat will 'click' into place.

Check the seat is secure before using it and use all the straps provided.



Removing the sibling seat.

Locate the two locking latches **(A)** on either side of the seat. Rotate the latch on both sides and lift the seat up.



WARNINGS

1. Sibling seat must be removed before folding the Verve Stroller frame
2. The sibling seat is not designed for and must NOT BE USED OR INSTALLED onto the Shuttle Discovery when using the Shuttle Discovery for transportation in motor vehicles.

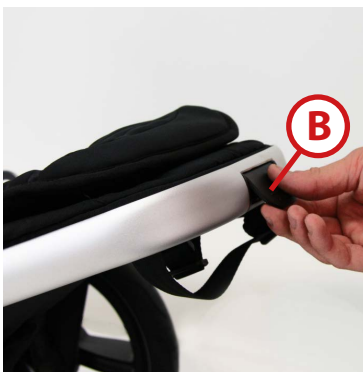

Backrest Angle

To change the backrest angle lift the lever **(B)** located on the top of the backrest.

Position the backrest into one of the three positions provided and release the lever to lock the backrest angle.

Upholstery and Fabric covers

Day to Day cleaning

Padding should be wiped regularly with soapy water or antibacterial spray. Please dry covering material thoroughly after wiping.

Deep cleaning

Fabric covers can be machine washed at 40°C (104°F) - or on the warm water setting. Remove the foam from the covers before washing the covers.



To remove thoracic support covers, undo the two screws (A) first and detach the complete support. Remove the covers from the moulded foam. Store the fasteners in a safe place and out of reach from children.

To remove the backrest cover, the shoulder straps need to be removed first. Lift the cam lock buckle (B) at the rear of the backrest and pull the strap through the padding.

The 5 point harness, pelvic straps, foot straps and sternum jacket can also be machined washed at 40°C (104°F) or on the warm water setting. Ensure the straps are refitted as instructed in this manual under the Accessories: 5 Point Harness & Pelvic Straps section.

Store the plastic triglides (as shown in image at right) in a safe place and out of reach from children.



Medifab recommends using AHP (Accelerated Hydrogen Peroxide) disinfectant wipes. The disinfection product must be used as per the manufacturer instructions. Medifab takes no responsibility for the effectiveness of the disinfecting process.



Metal, Plastic & Wooden components

Day to Day cleaning

Metalwork, plastic and wooden parts can be wiped with soapy water or antibacterial spray. Please dry the product thoroughly. Do NOT use solvents, abrasive cleaners, caustic soda, sodium hypochlorite and organic solvents.

Before cleaning the Hi Lo base, make sure the base is in its lowest position to avoid degreasing the gas piston or electric actuator.

Do not use a high pressure spray to clean the Hi Lo base.

Deep cleaning

For deep cleaning a low pressure steam cleaner can be also be used. We recommend that the Verve Stroller wheels are cleaned on a 6-monthly basis.

Medifab recommends using AHP (Accelerated Hydrogen Peroxide) disinfectant wipes. The disinfection product must be used as per the manufacturer instructions. Medifab takes no responsibility for the effectiveness of the disinfecting process.

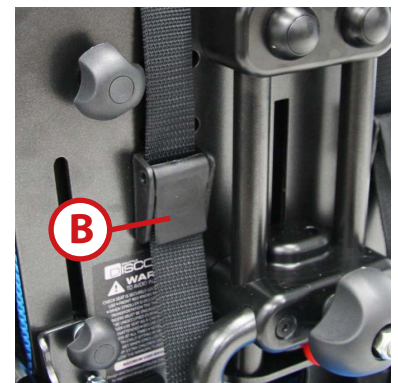

Reissuing the product

The following points must be observed before re-issuing Shuttle Discovery. Ensure that the product is standard and that no special attachments or modifications have been made. Ensure that the Shuttle Discovery meets the new user's needs.

Each product has a serial number located on it. Do not remove this label.

Detailed checks / inspections should be carried out on the product by a technically competent person who has been trained in the use of this product. Follow the six monthly checks outlined on pages 60-62. If you are not able to carry out the outlined checks please contact Medifab or your local dealer, who will be happy to arrange a full service for your Shuttle Discovery.

A written record should be kept of six monthly checks, services, repairs and setups. Please fill in the product log form at the rear of this manual.

Ensure the Shuttle Discovery has been fully cleaned as per this manual.

Always ensure that a new user manual is supplied each time the product is reissued. For a new manual please contact Medifab or your local dealer. You can also download the manual from our website: www.medifab.com or email us at info@medifab.com.

If the product is being delivered always ensure that it is packed securely to avoid damage.

Maintenance: Daily Checks

The following visual checks must be made before every use.

Verve Stroller

- Check the stroller is moving smoothly and functioning correctly. Any unusual noise, vibration or movement in the product could be caused by loose fasteners or damage to the product.
- Contact your Shuttle Discovery distributor, health care provider or Medifab should you need further assistance. who will assist you to correct any problems.
- Check the push handle feels rigid and there is no gap at the folding joint.
- Do not use the product until the problem is rectified.

Discovery Seat

- Check the 5 point harness / 4 point pelvic strap / 2 point pelvic strap / chest harness is / are securely fitted to the seat.
- Check the backrest angle is secure and tight.
- Check the footplate angle and height is secure and tight.
- Check all the upholstery for wear and tear.
- Check all the adjustment levers and knobs are in place and secure.

Hi-Lo Base

- Check the Discovery Seat is securely mounted on the Hi-Lo Base.
- Check that the castors are locking tightly.
- Check the Hi-Lo Base for wear and tear or breaks.
- Check no wires are exposed on the handset.

Moon Rock Base

- Check the Discovery Seat is securely mounted on the Moon Rock Base.
- Check the anti-rock bars both lock.
- Check the frame for wear and tear, splinters or breaks.

Lunar Base

- Check the Discovery Seat is securely mounted on the Lunar Base.
- Check each of the four legs to ensure they are secure and level.
- Check the frame for wear and tear, splinters or breaks.



WARNINGS

1. After transferring the user into any of the bases, check all the positioning straps fit the user snugly.
2. Always keep your Shuttle Discovery System clean. If you have been to the beach, completely clean the Shuttle Discovery afterwards to remove the sand and salt from the mechanisms and wheels.

Maintenance: Six-monthly Checks

The frequency of the six-monthly check is only a minimum and should be adjusted depending on the environment in which the equipment is used. We recommend you maintain a record of check by filling in the product log form at the end of this manual.

Discovery Seat

1. Check the 5 point harness / 4 point pelvic strap / 2 point pelvic strap / chest harness are securely fitted to the seat and functioning correctly.
2. Check the backrest, thoracic, pelvic, footplate, headrest, abduction and adduction supports are secure and tight.
3. Check the backrest angle is secure and tight.
4. Check the tilt in space mechanism is working smoothly and the seat feels secure.
5. Check the tilt in space release lever is operating the tilt in space mechanism correctly. Pay particular attention to the cable tension, to ensure this is not too tight so that it can tilt without operating the tilt lever.
6. Check the seat mounting, backrest angle and tilt in space safety plungers are all secure and locking.
7. Replace any missing or worn fasteners / adjusting levers and knobs.
8. Inspect the backrest and footplate pivot points. Ensure the fasteners are not loose.
9. Inspect the two pivot brackets under the seat, ensure the fasteners are not loose.
10. Inspect the seat depth adjustment screws under the seat padding, ensure the fasteners are tight.
11. Check all the straps for fraying and missing or broken buckles.
12. Check all the upholstery for wear and tear.
13. Check the seat framework for wear and tear, splinters or breaks.
14. Check the overall structure of the Discovery Seat for any signs of fatigue or damage.

Verve Stroller

For pneumatic tyres only: Check the air pressure in the wheels. Max air pressure 1.5 bar (20 psi).

Check the frame for wear and tear, splinters or breaks.

1. Check the stroller is moving smoothly and functioning correctly. Any unusual noise, vibration or movement in the product could be caused by loose fasteners or damage to the product. Contact your Shuttle Discovery distributor, health care provider or Medifab should you need further assistance. who will assist you to correct any problems. Do not use the product until the problem is rectified.
2. Check the push handle feels rigid and there is no gap at the folding joint.



WARNING

Gap at the folding joint can be a possible finger trap for the end user and caregiver



No Gap at the folding joint



Gap at the folding joint and locking disc protruding

If there is a gap at the folding joint, please follow the steps listed below.

- a) Ensure the folding tab is in the lock position i.e pointing down.
- b) On the inner side of the frame, tighten the M6 nyloc nut (as shown in the blue circle) located in the center of the folding joint by a quarter turn at a time.
- c) After each quarter turn, check if the gap is closing and assess the tension on the folding tab. The folding tab should open and close with light pressure. If there is still a gap follow the above step again until the gap is no more, the push handle feels rigid and the locking disc is not protruding from the locking joint.

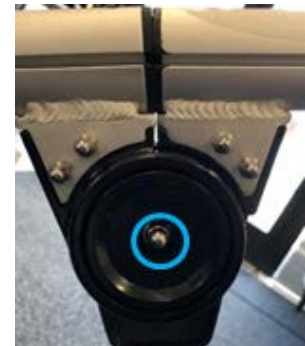

WARNING

Over tightening the M6 nyloc nut will damage the T bolt within the folding joint assembly and open up a gap at the folding joint which can be a possible finger trap for the end user and caregivers.

- d) Check the folding joint assembly on the outside of the frame, if the T bolt (located in the folding tab) is damaged i.e. looks misshapen or does not have a black plastic shroud covering it, please request a replacement and **DO NOT USE THE STROLLER.**



Damaged T Bolt is visible through the folding tab



T Bolt is not damaged

T Bolt



e) With the correct T-bolt tension, there should be no gap at the folding joint, the locking disc should not be protruding, and the push handle should feel rigid.

f) Tighten the small nuts on the inner side of the frame (shown in Yellow).

g) If there is still a gap at the folding joint, please contact your local dealer or Medifab and **DO NOT USE THE STROLLER.**

3. Check the rear wheels are locking securely. Remove any dirt and ensure the wheels are turning freely.
4. Check the front wheel / wheels swivel lock is working correctly.
5. Check the fasteners that secure the front and the rear seat mounting bars are tight.
6. Check the overall Stroller structure for any signs of fatigue or damage. Check the frame for wear and tear, splinters or breaks.

Hi-Lo Base

1. There are 8 x M6 bolts and nuts on the electric base, please tighten all the nuts with a 10mm ring spanner and a 4mm Allen key. Ensure the at least two threads are visible past the nylon ring on the nut (if you have a torque wrench, the correct torque is 5Nm).
2. Check the gas spring is providing adequate force to assist with the height adjustment. If the gas spring force has become weak over time request a replacement gas spring.
3. Check the safety lock plunger on the foot pedal is in working order.
4. Check the mounting bars for the seat on the base are tightly secured to the base interface mounting.
5. If the base is squeaking apply a small amount of lubricant to all the joints.
6. Check the overall integrity of the Hi-Lo base, i.e. there should be no loose parts and the base should stand flat on the ground.
7. Check the castors are free from dirt and lock securely.
8. Check the battery is holding its charge.
9. Ensure the safety plunger is in working order on the gas assisted Hi-Lo base.
10. Check the handset is in working order and the curly cable is not damaged or any wires exposed.
11. Check there is no damaged to the actuator or the control box at the rear of the frame.
12. Do not open any of the electronic components. Only an authorised LINAK service agent center should repair the LINAK electric actuator system.

Moon Rock Base

1. Check the two sides of the Moon Rock Base are tight.
2. The front and rear anti rock mechanism is functioning correctly and firmly secured to the sides.
3. Check front and rear mounting bars are secure.
4. Check the overall Moon Rock Base structure for any signs of fatigue or damage.
5. Check the frame for wear and tear, splinters or breaks.
6. Replace any missing or worn fasteners / adjusting levers and knobs.

Lunar Base

1. Check the two sides of the Lunar Base are tight.
2. Check each of the four legs are tightly secured to the base and level.
3. Check the overall Lunar Base structure for any signs of fatigue or damage.
4. Check the frame for wear and tear, splinters or breaks.
5. Replace any missing or worn fasteners.



WARNING

If a fault is found with any part of the Shuttle Discovery System, do not use the product until the fault is rectified. Contact Medifab customer service department or your local dealer immediately for guidance.

Disposal & Recycling

Your Shuttle Discovery is manufactured using a variety of materials, most of which can be recycled.

Once it reaches the end of its life, if you are the legal owner, do not dispose of as ordinary household waste but take your Discovery to an approved recycling or collection point, to dispose of according to local laws and regulations. Separate collection and recycling of the Discovery when disposing ensures protection of the environment and assists with natural resource conservation.

The Shuttle Discovery system should be serviced annually once out of the warranty period.

If you suspect the Shuttle Discovery has had heavy usage and is still under warranty we recommend you request a full service.

Shuttle Discovery should only be serviced by a technically competent person/health care provider who has been trained in the use of the product, a Medifab authorised person or a local distributor.

Please contact Medifab customer services department or your local dealer for further information.

Service Life: Medifab recommends that the Shuttle Discovery can be used for a period of 4 years, provided the product is maintained and serviced as per manufacturer's instructions.

Product identification serial number

1. **Discovery Seat:** Located on the backrest.
2. **Verve Stroller:** Located on the inside of the stroller frame.
3. **Hi-Lo Base:** Located on the rear of the base.
4. **Moon Rock Base:** Located on the inside face of the side.
5. **Lunar Base:** Located on the side of the base.

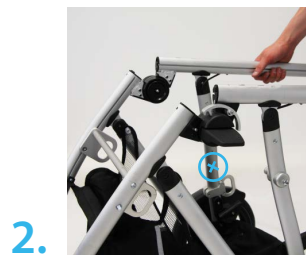

Product raw material

1. **Discovery Seat:** Aluminium & Plastic
2. **Verve Stroller:** Aluminium & Plastic
3. **Hi-Lo Base:** Mild Steel & Plastic, Electric Lead Acid Battery
4. **Lunar Base:** Wood & Aluminium
5. **Moon Rock Base:** Wood & Aluminium
6. **Plastic Parts:** High Density Polyethylene
7. **Cushion:** Polyurethane and EVA (Ethylene vinyl acetate) foams
8. **Fabric:** Polyester and Nylon fabrics

Example Product Identification Serial Label (for Seat)

		New Zealand: 32 Detroit Drive, Rolleston 7675 Australia: 26 Pardoe Street, Devonport, TAS 7310 NZ Call +64 3 307 9790 • AU Call +61 3 6427 0105 solutions@medifab.com • www.medifab.com	
REF	2006-0010-000	Name	Discovery Seat
SN		Weight	25 kg / 55 lbs (seat)
LOT		Weight	55 kg / 121 lbs (chassis)
consult instructions for use		EC	REP
		BEO MedConsulting Berlin GmbH, Helmholtzstr. 2, 10587 Berlin Germany, Tel.: +49-30-318045-51	Medicept, 200 Homer Ave, Ashland MA 01721, United States, Tel.: +1-508-231-8842

Medifab Service Distributor

Please record the Medifab Distributor from which you purchased your Shuttle Discovery.

Company			
Address			
Phone		Website	
Contact		Email	
Serial #			

<i>Shuttle Discovery</i>	
Overall length with legrest	93 cm / 36.6"
Overall width	65 cm / 25.6"
Folded length	84 cm / 33"
Folded width	65 cm / 25.6"
Folded height	61 cm / 24"
Total Mass	20 kg / 44 lb
Mass of the heaviest part	12.5 kg / 27.6 lb
Static stability downhill	0-10°
Static stability uphill	0-10°
Static stability sideways	0-10°
Seat plane angle	90-160°
Effective seat depth	14-30 cm / 5.5-11.8"
Effective seat width	13-27 cm / 5.1-10.6"
Seat surface height at front edge	64 cm / 25.2"
Backrest angle	90-60°
Backrest height	45-58 cm / 17.7-22.8"
Footrest to seat distance	14-28 cm / 5.5-11"
Leg to seat surface angle	90-160°

<i>Lunar Base: 2006-0013-000</i>	
Frame width	43 cm / 17"
Frame length	63 cm / 24.8"
Frame height	17-28 cm / 6.7-11"
Seat to floor height	22-32 cm / 8.6-12.6"
Load capacity	40 kg / 88.1 lb
Weight	2.5 kg / 5.5 lb

<i>Moon Rock Base: 2006-0011-000</i>	
Frame width	41 cm / 16.1 lb
Frame length	71 cm / 22.9"
Frame height	27.5 cm / 10.8"
Seat to floor height	34 cm / 13.3"
Load capacity	40 kg / 88.1 lb
Weight	3.4 kg / 7.4 lb

<i>Hi-Lo Base:</i>	<i>Gas: 2006-0016-000</i>	<i>Powered: 2006-0018-000</i>
Frame width overall	57 cm / 22.4"	57 cm / 22.4"
Frame length	69 cm / 27" (excluding handle)	69 cm / 27" (excluding handle)
Push Handle Height	70.5-106.5 cm / 27.8-41.9"	71.5-107.5 cm / 28.1-42.3"
Seat to floor height	33-69.5 cm / 13-27.4"	33.5-69.5 cm / 13.2-27.4"
Load capacity	50 kg / 110.2 lb	50 kg / 110.2 lb
Weight	18 kg / 39.7 lb	22 kg / 48.5 lb

Manual: Discovery20200907

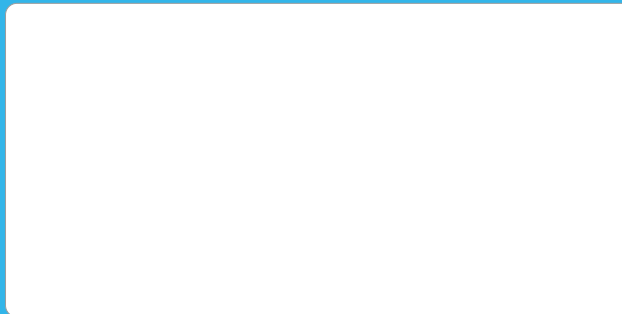

medifab



Phone +64 3 307 9790
Fax +64 3 307 2820
solutions@medifab.com

www.medifab.com

New Zealand Head Office
32 Detroit Drive
Rolleston 7675
Call 0800 543 343

US	REP	EC	REP
Medicept 200 Homer Ave, Ashland, MA 01721 United States Tel: +1-508-231-8842		BEO MedConsulting Berlin GmbH Helmholtzstr. 2 D-10587 Berlin, Germany Tel: +49-30-318045-30	

Australian Head Office
26 Pardoe Street
East Devonport, TAS 7310
Call 1300 543 343