

spex for BINGO



FOR HOGGI STROLLERS

AUSTRALIAN
SCRIPTING AND ORDERING GUIDE

December 2023

Client Details

| | | |
|--------------------------|--|--------------|
| Client/User name: | | Notes |
| Date: | | |
| DOB: | | |

Measurements

| Select Size | Size 1 | Size 2 | | | |
|---------------------|-------------------------------------|---|-------------------------|------------------------|------------------------|
| Order Code | 2885-0031-032 | 2885-0032-032 | | | |
| Seating specs | A Hip width | 17-28cm (6.5-11") | 22-33cm (8.5-13") | | |
| | B Seat depth | 18-30cm (7-12") | 23-38cm (9-15") | | |
| | C Back height | 36-44cm (14-17") | 40-48cm (16-19") | | |
| | D Lower leg length* | 25-40cm (10-16") | 25-45cm (10-18") | | |
| | E Trunk lateral width | 12-28cm (5-11") | 15-30cm (6-12") | | |
| | F Trunk lateral height | 15-34cm (6-13.5") | 17-40cm (6.5-16") | | |
| | G Arm support height | 15-22cm (6-8.5") | 15-22cm (6-8.5") | | |
| | H Internal arm support width | 20-32cm (8-13") | 28-38cm (11-15") | | |
| | I Head support height | 45-65cm (18-25.5") | 50-70cm (20-28") | | |
| | J Cushion total width | 33cm (13") Size 1.1 | 33cm (13") Size 1.2 | 38cm (15") Size 2.1 | 38cm (15") Size 2.2 |
| | K Cushion total depth | 33cm | | 38cm | |
| | L Internal cushion width | 23cm (9") Size 1.1 | 28cm (11") Size 1.2 | 28cm (11") Size 2.1 | 33cm (13") Size 2.2 |
| | M Centre of thigh contours | 15cm (6") Size 1.1 | 17cm (6.5") Size 1.2 | 18cm (7") Size 2.1 | 20cm (8") Size 2.2 |
| | N Thigh contour depth | 10cm (4") Size 1.1 | 12cm (5") Size 1.2 | 12cm (5") Size 2.1 | 15cm (6") Size 2.2 |
| | O Cushion side height | 14cm (5.5") | | 14cm (5.5") | |
| | P Thigh contour height | 9cm (3.5") | | 9cm (3.5") | |
| | Q Abductor contour height | 5cm (2") | | 5cm (2") | |
| | R Back cushion width | 33cm (13") | | 38cm (15") | |
| | S Trunk cushion width | 26cm (10") | | 30cm (12") | |
| Stroller specs | Frame seat depth capacity | 18-30cm (7-12") | 20-38cm (8-15") | | |
| | Frame back height capacity | 36-46cm (14-18") | 41-55cm (16-22") | | |
| | Backrest recline angle | 90-160° | | | |
| | Height of push bar | 75-110cm (29.5-43") | | | |
| | Overall frame width | 63cm (25") | 68cm (27") | | |
| | Max load of seat unit | 50kg (110lb) (body weight including other load) | | | |
| Base frame capacity | 60kg (132lb) | | | | |

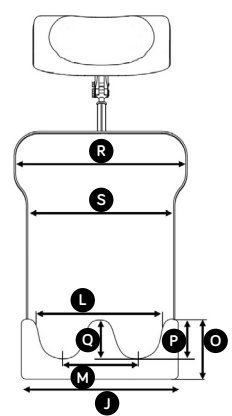
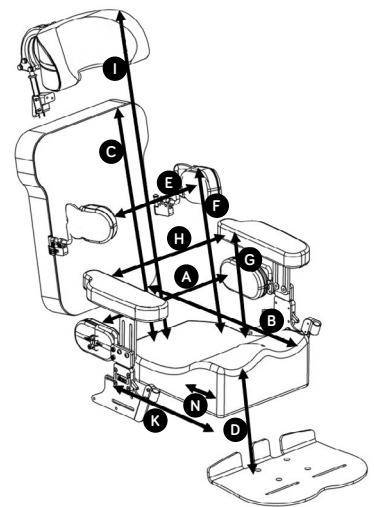

The BINGO Spex package includes:

- Matte black frame with tie downs
- 3kg fabric basket
- Tray table
- Sun canopy



FABRIC BASKET

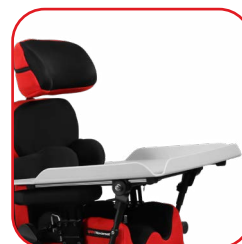





TRAY TABLE







SUN CANOPY

Colour Selection

(Express delivery on colours stocked in our Devonport Warehouse).

| Jet | Royal | Chilli | Mango | Bumblebee |
|---|---|---|---|---|
|  |  |  |  |  |
| -099 | -077 | -022 | -030 | -044 |

| Ocean | Leaf | Calypso | Granite | Ink / Wipe Down |
|---|---|---|---|---|
|  |  |  |  |  |
| -060 | -054 | -028 | -090 | -209 |

Cushion Selection

| Size 1.1 | Size 1.2 | Size 2.1 | Size 2.2 |
|---|--|--|--|
| Fits BINGO Size 1 | | Fits BINGO Size 2 | |
| 33cm (13") total width 23cm (9") internal width (Recommended for 18-23cm seat depth) 2885-0610-XXX | 33cm (13") total width 28cm (11") internal width (Recommended for 23-30cm seat depth) 2885-0611-XXX | 38cm (15") total width 28cm (11") internal width (Recommended for 23-33cm seat depth) 2885-0612-XXX | 38cm (15") total width 33cm (13") internal width (Recommended for 28-38cm seat depth) 2885-0613-XXX |
| Spare Cover: 2885-0660-XXX | Spare Cover: 2885-0661-XXX | Spare Cover: 2885-0662-XXX | Spare Cover: 2885-0663-XXX |



Back Supports

| Spex Contouring Back System | |
|---|---|
| For Size 1 BINGO 2885-2012-XXX Spare Cover: 2885-2062-XXX | For Size 2 BINGO 2885-2014-XXX Spare Cover: 2885-2064-XXX |





Head Supports

| Standard Lateral | Extended Lateral | Mount and Stem Hardware |
|--|---|--|
| With Stylo hardware & BINGO attachment | | |
| For moderate head positioning needs. 2885-4241-XXX Spare Cover: 2885-4261-XXX | For complex head positioning needs. 2885-4341-XXX Spare Cover: 2885-4361-XXX | For use with other Spex head pads 2885-4510-000 |





Arm Supports

| Arm Supports | | Pelvic Supports | |
|--|---|---|---|
| With height-adjustable, quick-release hardware and neoprene cover. |  | Mounts onto arm support bracket (pair) behind cushion trough (arm supports must be selected). |  |
| To fit Size 1 2885-5621-291 | | To fit Size 1 2885-1111-000 | |
| To fit Size 2 2885-5622-291 | | To fit Size 2 2885-1112-000 | |

Lateral Supports

| Narrow lateral supports | Broad lateral supports |
|---|--|
| Soft padding/neoprene cover (pair) with Axial Technology. 8.5cm high x 11.5cm deep 2885-3410-291 | Soft padding/neoprene cover (pair) with Axial Technology. 10.5cm high x 13cm deep 2885-3431-291 |
|  |  |

OPTIONAL SELECTION ITEMS

Shoulder Harness

| X-Small Centrepont | Small Centrepont |  |
|--|--|---|
| Pad height 26cm, total pad width 22cm 1409-6660-017 | Pad height 36cm, total pad width 32cm 1409-6661-017 | |

Hip Belt

| 2 Point Hip Belt | 4 Point Hip Belt |
|---|---|
| 2-point, padded dual centre pull, side release buckle. | 4-point, padded dual centre pull, side release buckle. |
| X-Small (Pad width 30cm) 1405-6220-027 | X-Small (Pad width 30cm) 1406-6420-027 |
| Small (Pad width 36cm) 1405-6221-027 | Small (Pad width 36cm) 1406-6421-027 |
|  |  |

Feet Positioning

| Footplate Spacer Block* | Foot positioning sandals | Height kit / raiser blocks |
|---|--|---|
| <p>Size 1 (10/11") 2885-5321-000</p> <hr/> <p>Size 2 (12/13") 2885-5322-000</p> | <p>May require height kit/s. 2885-6081-000</p> | <p>For foot positioning sandals (kit of 4). 2885-6091-000</p> |

*Can not be used with foot positioning sandals

Critical Care Options

| IV Pole | Extra Bracket | Oxygen Bottle Holder |
|--|--|--|
| <p>With mobility bracket for attachment to mobility base. Fits both Size 1 and Size 2. 2880-8275-000</p> | <p>For QR mounting of IV pole to second base (Cobra or other indoor base). 2880-8275-050</p> | <p>With mounting bracket for attachment to mobility base. 120mm diameter for 'C Type' bottle. Fits both Size 1 and Size 2. 2880-8253-000</p> |

Chassis Mount Tray

For high dependency equipment - suction/oxygen etc.

| | |
|---|---|
| <p>Size 1 (for BINGO Size 1) 2880-8058-000</p> |  |
| <p>Size 2 (for BINGO Size 2) 2880-8059-000</p> | |

Swivel Lock

For both Size 1 and Size 2

| | |
|---|---|
| <p>To hold castors straight when brisk walking. 2880-8440-000</p> |  |
|---|---|

Hand Strap

Wrist safety tether strap

| | |
|----------------------|---|
| <p>2005-6930-000</p> |  |
|----------------------|---|

Tray Therapy Tray Infill

Therapy Tray Infill

| | |
|---|---|
| <p>For smaller trunk cut out. 2880-7180-000</p> |  |
|---|---|

Indoor Base

Cobra high-low indoor frame with 75mm castors

Size 1 (for BINGO Size 1)
2880-8711-000

Size 2 (for BINGO Size 2)
2880-8721-000

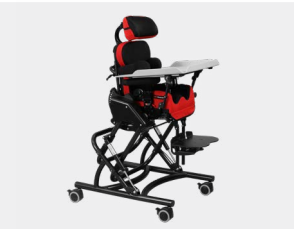

Separate Seat Unit

Use with Cobra Base

Separate seat unit for use with the Cobra Base if a combined stroller and seat unit is not purchased. This is also a great option if two seat units are preferred to avoid swapping the seat unit between the stroller and Cobra bases. Must be purchased with upholstery.

Size 1
2885-0011-032

Size 2
2885-0012-032

spex

Manufactured by Spex Ltd

solutions@spexseating.com

spexseating.com



DISTRIBUTED BY:

Script BINGOSpex_20231215_AU