

spex for BINGO



FOR HOGGI STROLLERS

NEW ZEALAND
SCRIPTING AND ORDERING GUIDE

December 2023

Client Details

Client/User name:		Notes
Date:		
DOB:		

Measurements

Select Size	Size 1	Size 2			
Order Code	2885-0031-032	2885-0032-032			
Seating specs	A Hip width	17-28cm (6.5-11")	22-33cm (8.5-13")		
	B Seat depth	18-30cm (7-12")	23-38cm (9-15")		
	C Back height	36-44cm (14-17")	40-48cm (16-19")		
	D Lower leg length*	25-40cm (10-16")	25-45cm (10-18")		
	E Trunk lateral width	12-28cm (5-11")	15-30cm (6-12")		
	F Trunk lateral height	15-34cm (6-13.5")	17-40cm (6.5-16")		
	G Arm support height	15-22cm (6-8.5")	15-22cm (6-8.5")		
	H Internal arm support width	20-32cm (8-13")	28-38cm (11-15")		
	I Head support height	45-65cm (18-25.5")	50-70cm (20-28")		
	J Cushion total width	33cm (13") Size 1.1	33cm (13") Size 1.2	38cm (15") Size 2.1	38cm (15") Size 2.2
	K Cushion total depth	33cm		38cm	
	L Internal cushion width	23cm (9") Size 1.1	28cm (11") Size 1.2	28cm (11") Size 2.1	33cm (13") Size 2.2
	M Centre of thigh contours	15cm (6") Size 1.1	17cm (6.5") Size 1.2	18cm (7") Size 2.1	20cm (8") Size 2.2
	N Thigh contour depth	10cm (4") Size 1.1	12cm (5") Size 1.2	12cm (5") Size 2.1	15cm (6") Size 2.2
	O Cushion side height	14cm (5.5")		14cm (5.5")	
	P Thigh contour height	9cm (3.5")		9cm (3.5")	
	Q Abductor contour height	5cm (2")		5cm (2")	
	R Back cushion width	33cm (13")		38cm (15")	
	S Trunk cushion width	26cm (10")		30cm (12")	
Stroller specs	Frame seat depth capacity	18-30cm (7-12")	20-38cm (8-15")		
	Frame back height capacity	36-46cm (14-18")	41-55cm (16-22")		
	Backrest recline angle	90-160°			
	Height of push bar	75-110cm (29.5-43")			
	Overall frame width	63cm (25")	68cm (27")		
	Max load of seat unit	50kg (110lb) (body weight including other load)			
Base frame capacity	60kg (132lb)				

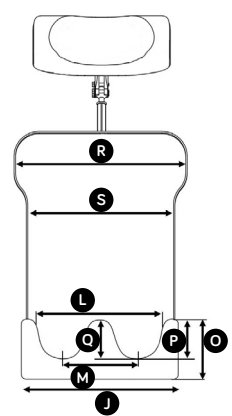
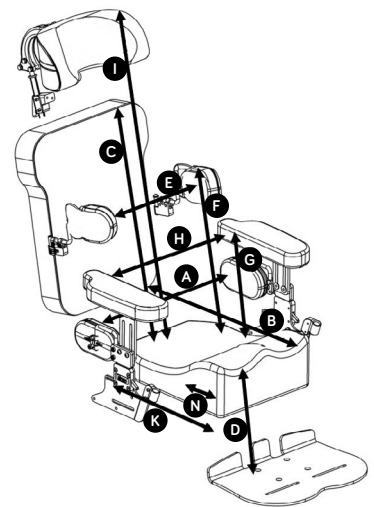

The BINGO Spex package includes:

- Matte black frame with tie downs
- 3kg fabric basket
- Tray table
- Sun canopy



FABRIC BASKET

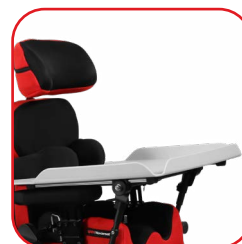

TRAY TABLE





SUN CANOPY

Colour Selection

(Express delivery on colours stocked in our Devonport Warehouse).

Jet	Royal	Chilli	Mango	Bumblebee
		 Express Delivery		
-099	-077	-022	-030	-044

Ocean	Leaf	Calypso	Granite	Ink / Wipe Down
 Express Delivery		 Express Delivery	 Express Delivery	
-060	-054	-028	-090	-209

Cushion Selection

Size 1.1	Size 1.2	Size 2.1	Size 2.2
Fits BINGO Size 1		Fits BINGO Size 2	
33cm (13") total width 23cm (9") internal width (Recommended for 18-23cm seat depth) 2885-0610-XXX	33cm (13") total width 28cm (11") internal width (Recommended for 23-30cm seat depth) 2885-0611-XXX	38cm (15") total width 28cm (11") internal width (Recommended for 23-33cm seat depth) 2885-0612-XXX	38cm (15") total width 33cm (13") internal width (Recommended for 28-38cm seat depth) 2885-0613-XXX
Spare Cover: 2885-0660-XXX	Spare Cover: 2885-0661-XXX	Spare Cover: 2885-0662-XXX	Spare Cover: 2885-0663-XXX



Back Supports

Spex Contouring Back System	
For Size 1 BINGO 2885-2012-XXX Spare Cover: 2885-2062-XXX	For Size 2 BINGO 2885-2014-XXX Spare Cover: 2885-2064-XXX





Head Supports

Standard Lateral	Extended Lateral	Mount and Stem Hardware
With Stylo hardware & BINGO attachment		
For moderate head positioning needs. 2885-4241-XXX Spare Cover: 2885-4261-XXX	For complex head positioning needs. 2885-4341-XXX Spare Cover: 2885-4361-XXX	For use with other Spex head pads 2885-4510-000







Arm Supports

Arm Supports		Pelvic Supports	
With height-adjustable, quick-release hardware and neoprene cover.		Mounts onto arm support bracket (pair) behind cushion trough (arm supports must be selected).	
To fit Size 1 2885-5621-291		To fit Size 1 2885-1111-000	
To fit Size 2 2885-5622-291		To fit Size 2 2885-1112-000	

Lateral Supports

Narrow lateral supports	Broad lateral supports
Soft padding/neoprene cover (pair) with Axial Technology. 8.5cm high x 11.5cm deep 2885-3410-291	Soft padding/neoprene cover (pair) with Axial Technology. 10.5cm high x 13cm deep 2885-3431-291
	

OPTIONAL SELECTION ITEMS

Shoulder Harness

X-Small Centrepont	Small Centrepont	
Pad height 26cm, total pad width 22cm 1409-6660-017	Pad height 36cm, total pad width 32cm 1409-6661-017	

Hip Belt

2 Point Hip Belt	4 Point Hip Belt
2-point, padded dual centre pull, side release buckle.	4-point, padded dual centre pull, side release buckle.
X-Small (Pad width 30cm) 1405-6220-027	X-Small (Pad width 30cm) 1406-6420-027
Small (Pad width 36cm) 1405-6221-027	Small (Pad width 36cm) 1406-6421-027
	

Feet Positioning

Footplate Spacer Block*	Foot positioning sandals	Height kit / raiser blocks
<p>Size 1 (10/11") 2885-5321-000</p> <hr/> <p>Size 2 (12/13") 2885-5322-000</p>	<p>May require height kit/s. 2885-6081-000</p>	<p>For foot positioning sandals (kit of 4). 2885-6091-000</p>

*Can not be used with foot positioning sandals

Critical Care Options

IV Pole	Extra Bracket	Oxygen Bottle Holder
<p>With mobility bracket for attachment to mobility base. Fits both Size 1 and Size 2. 2880-8275-000</p>	<p>For QR mounting of IV pole to second base (Cobra or other indoor base). 2880-8275-050</p>	<p>With mounting bracket for attachment to mobility base. 120mm diameter for 'C Type' bottle. Fits both Size 1 and Size 2. 2880-8253-000</p>

Chassis Mount Tray For high dependency equipment - suction/oxygen etc.	
<p>Size 1 (for BINGO Size 1) 2880-8058-000</p> <hr/> <p>Size 2 (for BINGO Size 2) 2880-8059-000</p>	

Swivel Lock

For both Size 1 and Size 2	
<p>To hold castors straight when brisk walking. 2880-8440-000</p>	

Hand Strap

Wrist safety tether strap	
<p>2005-6930-000</p>	

Tray Therapy Tray Infill

Therapy Tray Infill	
<p>For smaller trunk cut out. 2880-7180-000</p>	

Indoor Base

Cobra high-low indoor frame with 75mm castors

Size 1 (for BINGO Size 1)
2880-8711-000

Size 2 (for BINGO Size 2)
2880-8721-000

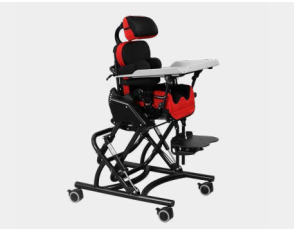

Separate Seat Unit

Use with Cobra Base

Separate seat unit for use with the Cobra Base if a combined stroller and seat unit is not purchased. This is also a great option if two seat units are preferred to avoid swapping the seat unit between the stroller and Cobra bases. Must be purchased with upholstery.

Size 1
2885-0011-032

Size 2
2885-0012-032

spex

Manufactured by Spex Ltd

solutions@spexseating.com

spexseating.com



DISTRIBUTED BY:

Script: BINGOSpex_20231215_NZ