

spex

Shaping Better Lives



XLella
Bariatric
Seating
Range



XLella is the Spex dedicated Bariatric Range catering for larger user needs and comprising of a range of back supports, cushions, and accessories.

Bariatric Seating Requirements

The bariatric population presents specific seating challenges. Positioning the pelvis in neutral may not be possible because excessive soft tissue limits the ability to control the position of the pelvis and spine, therefore, it is essential to provide adequate pressure distribution and relief, heat and moisture control, and ultimately, comfort.

The excessive adipose tissue in the gluteal region (gluteal shelf) can also prevent bariatric users from sitting with adequate spinal support, which can contribute to back pain. Offering solutions to accommodate the unique posterior shape created by this redundant tissue is paramount.

XLella bariatric range consists of back supports and cushions, which span from 22" to 28" width, with options for custom items up to 32". For sizes 21" and below, these are available in our regular Spex range.



XLella Back Support Range

The XLella back supports provide an off-the-shelf solution, with integrated adjustability and adaptability for potential changing needs. These are available in three different styles to meet the individual requirements and body shapes of the user, XLella Vigour, XLella Classic, and XLella². All models are transport certified and have a weight capacity of up to 300kg.



Vigour Back Support

Planar rigid bariatric back support for minimal postural requirements.



Classic Back Support

Rigid back support with contouring capabilities to shape and configure.



XLella² Back Support

A biangular back support with two adjustable sections to accommodate gluteal shelf and excess adipose tissue.





XLella Vigour Back Support

The XLella Vigour Back Support is designed to support users with larger pressure distribution who require planar padding to provide support for minimal postural requirements.





Shaping Better Lives

XLella Classic Back Support

The XLella Classic Back Support is designed to support users with larger pressure distribution who require a back support with the possibility to create shapes and contours for postural support and/or changing needs. The Spex unique contouring cube system can be shaped and configured as many times as needed.



Shape and Configure with Spex Technology

The XLella Classic model of Back Support features the Spex unique contouring cube system which can be shaped and configured as many times as needed. This provides the possibility to create shapes and contours for postural support and/or changing needs.



For mild bony prominences

Without even adjusting the cube system, the XLella Classic back support has slight contouring and integrates a comfortable pressure reducing foam surface layer to absorb mild bony prominences and asymmetries for uniform torso contact.

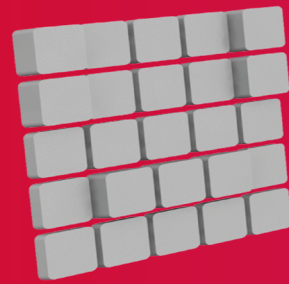

For immersion

For individuals that require immersion into the back support, simply adjust the cube contouring cell system to configure for a perfect fit and shape for the user's back.

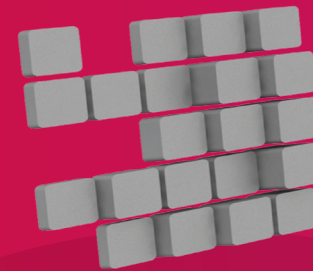

For asymmetry

For asymmetrical or maladaptive postures, the contour can be arranged to provide the matching shape required to support the user's torso profile.



XLella² Back Support

The XLella² provides a higher degree of trunk support by offloading the posterior side of the pelvis to accommodate a gluteal shelf. Its lower section has a total of 85° of adjustment, with 55° posterior and 30° anterior. This maximises pressure distribution and relief, to assure adequate postural support, and ultimately provide comfort.



Adaptive Profile Curvature System Contours to the Individual's Shape

The XLella² model of Back Support provides effective positioning through the adaptive Profile Curvature System that contours to the shape of the individual. Its lower section has a total of 85° of adjustment, with 55° posterior and 30° anterior. Match trunk profile with Adapta-Points and tighten to secure. Once tightened you can be confident the system will stay in place. Adjustments are made through each shell section offering flexibility as positioning needs change over time.

XLella Back Support Benefits



Purpose-Built for Bariatric Users

Heavy-duty and tough to meet the daily lifestyle demands of bariatric wheelchair users. The robust shell and hardware are not only tested and rated for heavier users up to 300kg, but their biomechanical design provides superior postural support and comfort for larger body shapes.



Dual-layer Outer Cover Technology

Dual-layer technology in the back support outer cover reduces shear forces, combating the likelihood of chafing and pressure sores. With air-mesh side panels and moisture-wicking front surface fabric; build-up of heat and moisture is limited. Covers can be easily removed and refitted after laundering.

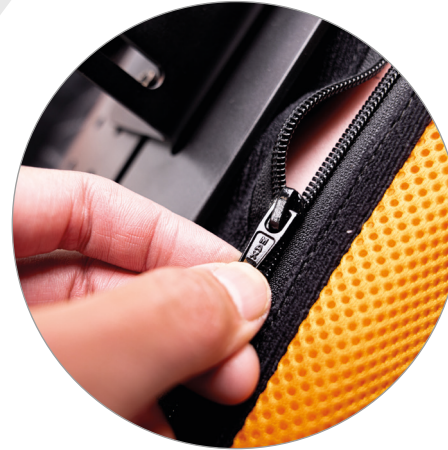

Easily Provide Additional Positioning

Increased positioning can be achieved through the use of wedge accessories and tessellated shapes for adaptable contouring.

Accessible cover design enables easy insertion of positioning components through zippers on the side of the padding.



Compatibility with Spex Postural Supports

XLella Back Supports are compatible with the standard Spex range of postural accessories including lateral trunk supports, anterior chest supports, and head supports.

Back Support Specifications

STYLE	XLELLA VIGOUR	XLELLA CLASSIC	XLELLA ²
WEIGHT* (WITHOUT HARDWARE, 22" BACK)	3.25kg	3.65kg	3.9kg
WEIGHT CAPACITY	300kg		
CONTOURING ANGLE ADJUSTMENT CAPABILITY	N/A	N/A	30° Anterior & 55° Posterior
OVERALL THICKNESS (INCLUDING COVER)	60mm	80mm	60mm
CODE	1258-WWHH-00H	1258-WWHH-OSS	1258-WWHH-200

Note: This is the weight of the 22" wide back support and does not include the hardware. For hardware weight see page 12.

Sizing Chart

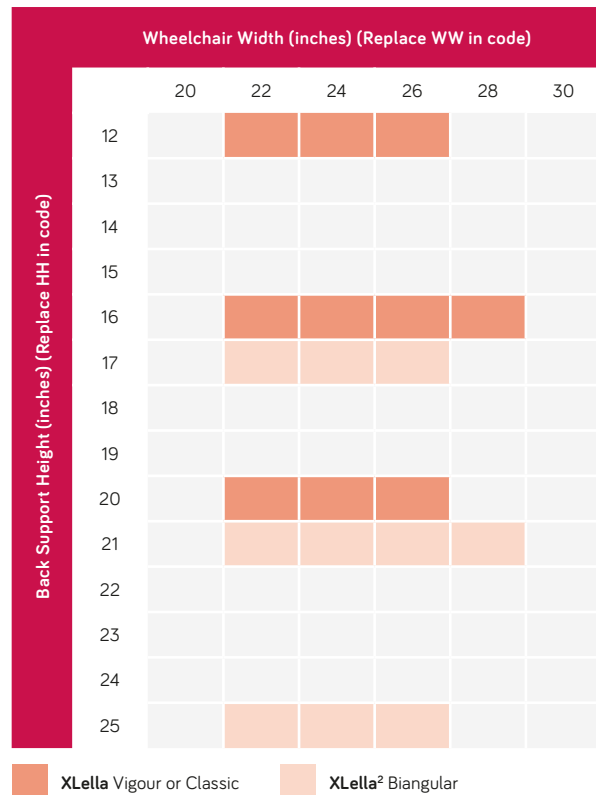

To order, replace the **HH** and **WW** in the code, with the appropriate size required

Transport Certified All XLella Back Supports and hardware configurations are suitable for transport in a vehicle when mounted on an appropriate wheelchair frame.

Foam Composition

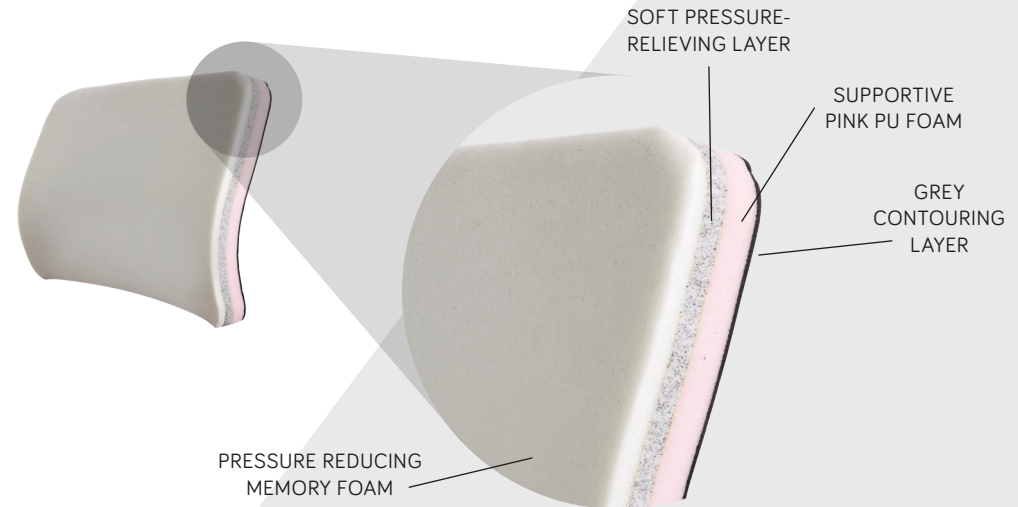

BACK SUPPORT STYLE	PRESSURE REDUCING MEMORY FOAM	SOFT PRESSURE RELIEVING FOAM	SUPPORTIVE PINK PU FOAM	GREY CONTOURING LAYER (EVA)
XLELLA VIGOUR	30mm	N/A	20mm	N/A
XLELLA CLASSIC	30mm	N/A	20mm	N/A
XLELLA ²	15mm	13mm	20mm	3mm

Hardware Options

Two options of mounting hardware tested and rated for heavier users (300kg weight limit).

Fixed Mount Bariatric Hardware

Default hardware choice for simplicity, with lower hardware weight. Fixes the back to the wheelchair for sturdy installation. Can easily be set in flipped orientation to allow greater seat depth adjustment.

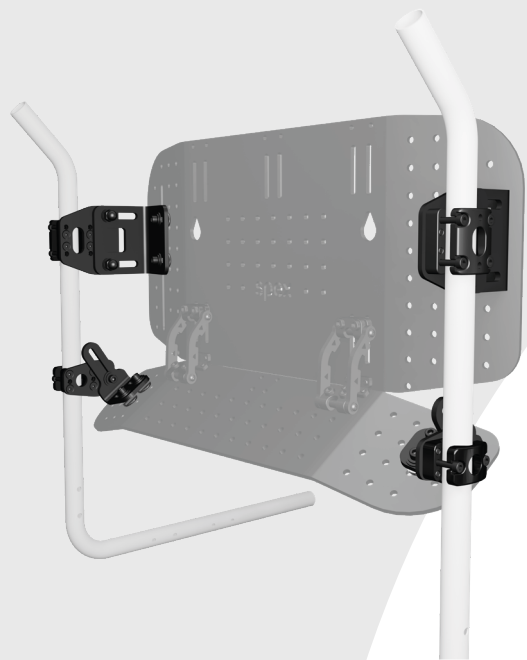

Quick-Release Bariatric Hardware

Allows easy removal of back support for use with folding wheelchairs or in situations the back is required to be removed.

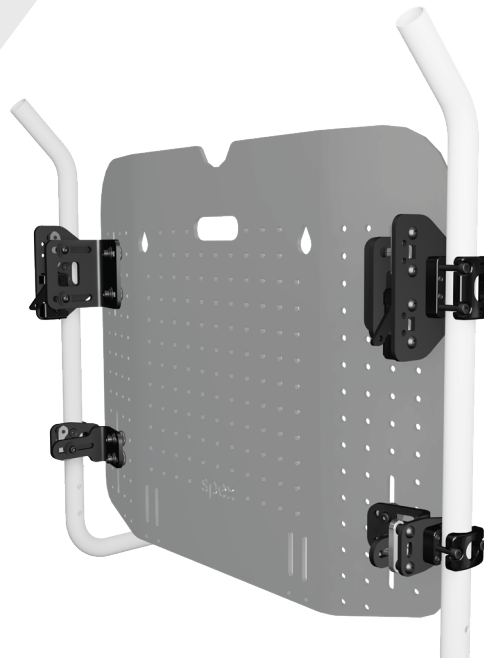

HARDWARE	XLELLA FIXED MOUNT	XLELLA QUICK RELEASE
WEIGHT	1.1kg	1.4kg
POINTS OF FIXATION	4	
FITS CANE SIZES	19-26mm	
BACK ANGLE ADJUSTMENT	+/-10°	
SEAT DEPTH ADJUSTMENT	0-30mm Flipped Orientation: 70-100mm	
OVERALL WIDTH ADJUSTMENT	50mm	
WEIGHT CAPACITY	300kg	
CODE	1259-2500-100	1259-2505-100

COMPATIBLE WHEELCHAIR WIDTH - XLELLA		
	XLELLA FIXED MOUNT	XLELLA QUICK RELEASE
BACK SUPPORT WIDTH	22"	22, 23, 24"
	24"	24, 25, 26"
	26"	26, 27, 28"
	28"	28, 29, 30"

Hardware in flipped orientation for greater seat depth.

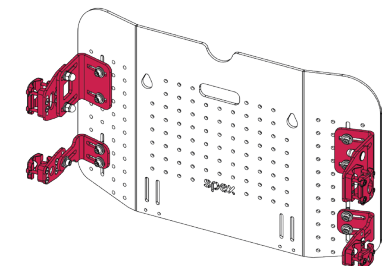

XLella Back Support Accessories



Cover Extension

Connects the back support and the cushion to ensure that any adipose tissue is protected. It wraps around the excess tissue and/or gluteal shelf to provide protection and privacy to the user.

Code:
1258-WW00-500



Lateral Reinforcement Plate

Recommended for clients with forceful side leaning or who weigh over 100kg.

Code: 1266-2450-100



Heavy-Duty kit for Stylo Head Support

This kit provides reinforcement at the shell connection and grub screws to improve the slip capacity at the ball connections.

Code: 1274-0000-HDK



Incontinence Cover

Fits inside the Outer cover for hygiene purposes and ease of cleaning.

Codes:
XLella Vigour:
1258-WWHH-00H-I
XLella Classic:
1258-WWHH-OSS-I
XLella²:
1258-WWHH-200-I

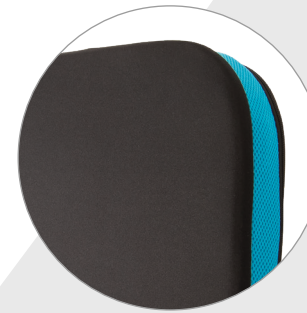

Extra Outer Back Support Cover

Useful to have available for laundering purposes.

Codes:
XLella Vigour:
1258-WWHH-00H-C
XLella Classic:
1258-WWHH-OSS-C
XLella²:
1258-WWHH-200-C

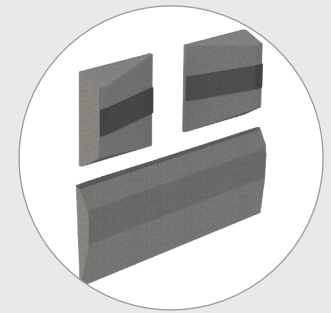

Back Support Lumbar Pad and Lateral Stability Wedges

Provide for positioning requirements. Additional wedge options are also available.

Code: 1209-2713-300

XLella Bariatric Cushion Range

The XLella cushions provide an off-the-shelf solution, with integrated adjustability and adaptability for potential changing needs. These are available in two different styles to meet the individual requirements and body shapes of the user, XLella Vigour Standard Contour and the XLella Classic (available in both Standard and High Contour). Both models are transport certified and have a weight capacity of up to 225kg.



XLella Vigour Cushion

(Available in Standard Contour)

The XLella Vigour with Standard Contour height, being a less complex and non-contourable option, is ideal for more active users who require a sturdy base of support and high degree of stability.



XLella Classic Cushion

(Available in both Standard and High Contour)

The XLella Classic which is available in either Standard or High Contour, features the renowned Spex Strategic Positioning Base, enabling the cushion to be configured to solve many different pelvis needs.

XLella Cushion Benefits



Sturdy Cushion Built with Enforced Lateral Support

The XLella cushions are built to support larger users. Featuring supportive lateral rigidisers along the sides of the cushion, these not only help to maintain the shape of the cushions but also add extra thigh support and alignment.



Robust Foam Construction

Constructed using higher density foams to ensure the durability and longevity of the cushion, allowing them to withstand a larger weight capacity whilst maintaining support and comfort over long periods of time. Specific foam construction differs from the regular Spex cushion models, easily visible by the change in colour and thickness.

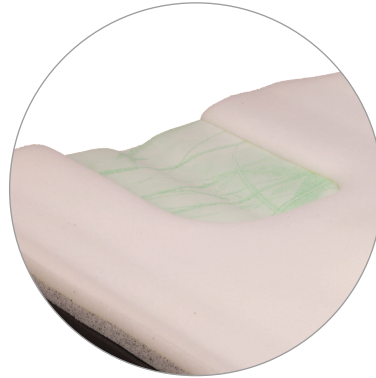

Refined Ischial Well Geometry

Developed specifically to accommodate larger body shapes, the ischial well geometry of the XLella cushion range has been refined to better suit the anatomy of bariatric users.



Dual Layer Cover Design to Reduce Chafing

Dual-layer technology in the cushion outer cover reduces shear forces, combatting the likelihood of chafing and pressure sores. With air-mesh side panels and moisture-wicking top surface fabric; build-up and the impacts of temperature are countered. Covers can be easily removed and refitted after laundering.



Incontinence Cover Supplied with Every Cushion

All XLella cushions come standard with an easily-removable incontinence cover for hygiene purposes and ease of cleaning.

XLella Cushion Specifications

WIDTH	CUSHION HEIGHT	WEIGHT CAPACITY	TROUGH HEIGHT	PRODUCT WEIGHT (22" X 22")
22-28"	3.75"	225kg	30mm (Standard Contour) 50mm (High Contour)	2.9kg

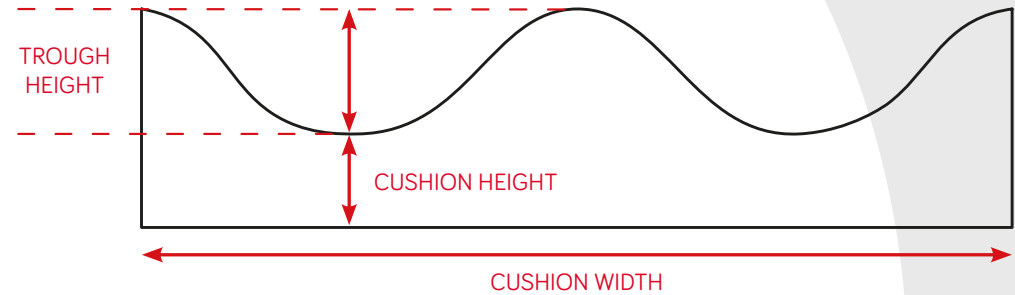

Sizing Chart

Cushion Depth (inches) (Replace DD in code)	Cushion Width (inches) (Replace WW in code)					
	20	22	24	26	28	30
18		Available	Available	Available	Available	
19					Available	
20		Available	Available	Available	Available	
21					Available	
22		Available	Available	Available	Available	
23					Available	
24			Available		Available	
25					Available	
26					Available	

Available XLella cushion size

Made to order XLella cushion size

Product Performance

Classic Standard Contour Cushion

Pressure Care			3		
Positioning				4	
Lateral Stability			3		
Offloading				4	
Changing Needs				4	

Classic High Contour Cushion

Pressure Care			3		
Positioning				4	
Lateral Stability				4	
Offloading				4	
Changing Needs				4	

Vigour Standard Contour Cushion

Pressure Care			3		
Positioning			3	4	
Lateral Stability			3	4	
Offloading			3	4	
Changing Needs	1				

These are used to compare the Spex products only.



Cushion Customisations & Accessories

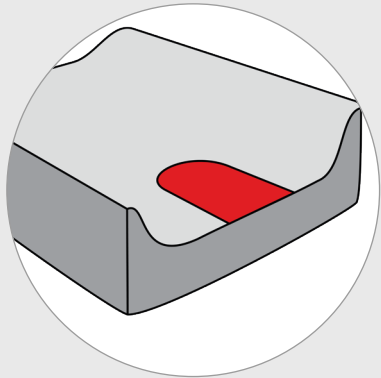

Remove Medial Thigh Contouring

Remove the Medial Thigh Support on the cushion so that a flat front surface is achieved without any contouring. This is ideal relief for excess tissue and a great option to facilitate easy transfers for users without natural adduction of the thighs.

Code: 1111-0335-000

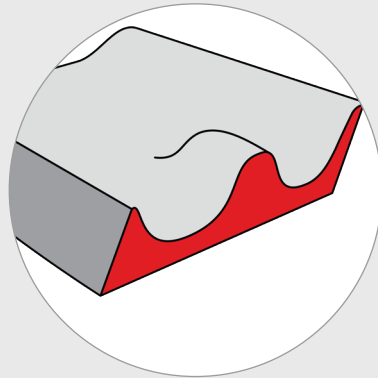

Front Surface Cut-back

Front surface cut-back, or a sloping front, can be achieved for users with excess tissue or to provide relief for users when transferring and/or foot propelling.

Code: 1111-0281-000



Extra Outer Cover

Codes:

XLella Vigour Std:

1123-WWDD-6SC

XLella Classic Std:

1125-WWDD-6SC

XLella Classic High:

1125-WWDD-6HC

(insert width & depth as relevant)



Extra Incontinence Cover

Codes:

XLella Vigour Std:

1133-WWDD-7SC

XLella Classic Std:

1135-WWDD-7HC

XLella Classic High:

1135-WWDD-7HC

(insert width & depth as relevant)

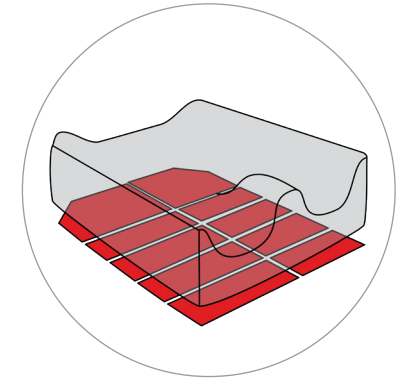

Extra Positioning Kit

Accessory for Spex Classic Cushions only

Code: 1111-0273-000

spex

Manufactured by Spex Ltd

32 Detroit Drive
Rolleston 7675
New Zealand

+64 3 307 9790

solutions@spexseating.com

spexseating.com

DISTRIBUTED BY:

